



24-10788-0, Rev. E
(barcode for factory use only)

TEC3000 Series Proportional Fan Coil and Individual Zone Thermostat Controllers with Dehumidification Capability

Installation Instructions

Part No. 24-10788-0, Rev. E
Issued July 2018

TEC3320-xx-xxx, TEC3321-xx-xxx, TEC3322-xx-xxx, TEC3323-xx-xxx,
TEC3620-xx-xxx, TEC3621-xx-xxx, TEC3622-xx-xxx, TEC3623-xx-xxx

Refer to the [QuickLIT website](#) for the most up-to-date version of this document.

Applications

The TEC3000 Series Proportional Fan Coil and Individual Zone Thermostat Controllers are stand-alone and field-selectable BACnet® MS/TP or N2 networked devices that provide control of the following:

- local hydronic reheat valves
- pressure-dependent variable air volume (VAV) equipment with or without local reheat
- two- or four-pipe fan coils
- cabinet unit heaters
- other individual zone equipment using a proportional 0 to 10 VDC control input

The networked models feature a field-selectable Building Automation System (BAS) BACnet MS/TP or N2 communication capability that enables remote monitoring and programming for efficient space temperature control. All models include a USB port configuration that reduces installation time by allowing simple backup and restore features from a USB drive, which enables rapid cloning of configuration between like units.

Some models have occupancy sensing capability built into the device. These thermostat controllers maximize up to 30% energy savings in high-energy usage commercial buildings, such as schools and hotels, during occupied times by using additional standby setpoints.

All models feature an intuitive onboard touchscreen UI with backlit display that makes setup and operation quick and easy. Multiple fan configurations are supported for fan coil equipment types:

- single-speed
- multi-speed (two or three discrete speeds)
- variable-speed/EC motors (0 to 10 VDC control)

Some models support dehumidification on two-pipe fan coil units with reheat, and four-pipe fan coil units with or without reheat. When no heating is required, the thermostat controller monitors space humidity and activates dehumidification control as necessary. Heat and/or reheat is used as required to maintain the space temperature. For optimal dehumidification performance, use a fan coil unit that has a multi-speed or variable-speed fan (VSF).

IMPORTANT: The TEC3000 Series Thermostat Controller is intended to provide an input to equipment under normal operating conditions. Where failure or malfunction of the thermostat controller could lead to personal injury or property damage to the controlled equipment or other property, additional precautions must be designed into the control system. Incorporate and maintain other devices, such as supervisory or alarm systems or safety or limit controls, intended to warn of or protect against failure or malfunction of the thermostat controller.

IMPORTANT: Le TEC3000 Series Thermostat Controller est destiné à transmettre des données entrantes à un équipement dans des conditions normales de fonctionnement. Lorsqu'une défaillance ou un dysfonctionnement du thermostat controller risque de provoquer des blessures ou d'endommager l'équipement contrôlé ou un autre équipement, la conception du système de contrôle doit intégrer des dispositifs de protection supplémentaires. Veiller dans ce cas à intégrer de façon permanente d'autres dispositifs, tels que des systèmes de supervision ou d'alarme, ou des dispositifs de sécurité ou de limitation, ayant une fonction d'avertissement ou de protection en cas de défaillance ou de dysfonctionnement du thermostat controller.

North American Emissions Compliance

United States

This equipment has been tested and found to comply with the limits for a Class B digital device, pursuant to Part 15 of the FCC Rules. These limits are designed to provide reasonable protection against harmful interference in a residential installation. This equipment generates, uses and can radiate radio frequency energy and, if not installed and used in accordance with the instructions, may cause harmful interference to radio communications. However, there is no guarantee that interference will not occur in a particular installation. If this equipment does cause harmful interference to radio or television reception, which can be determined by turning the equipment off and on, the user is encouraged to try to correct the interference by one or more of the following measures:

- Reorient or relocate the receiving antenna.
- Increase the separation between the equipment and receiver.
- Connect the equipment into an outlet on a circuit different from that to which the receiver is connected.
- Consult the dealer or an experienced radio/TV technician for help.

Canada

This Class (B) digital apparatus meets all the requirements of the Canadian Interference-Causing Equipment Regulations.

Cet appareil numérique de la Classe (B) respecte toutes les exigences du Règlement sur le matériel brouilleur du Canada.

Installation

Parts Included

- one TEC3000 Series Thermostat Controller with integral mounting base
- one installation instructions sheet

Location Considerations

Locate the TEC3000 Series Thermostat Controller:

- on a partitioning wall, approximately 5 ft (1.5 m) above the floor in a location of average temperature, allowing for vertical air circulation to the TEC
- away from direct sunlight, radiant heat, outside walls, outside doors, air discharge grills, stairwells, and from behind doors
- away from steam or water pipes, warm air stacks, unconditioned areas (not heated or cooled), or sources of electrical interference

For integrated passive infrared (PIR) models, be sure that the thermostat controller is located centrally, where occupant movement is frequent.

Use insulating foam pads for installations where wiring passes through the wall to the thermostat.

Note: Allow for sufficient clearance to insert a USB drive into the USB port.

Figure 1: Thermostat Controller Shown without Occupancy Sensor, Dimensions, in. (mm)

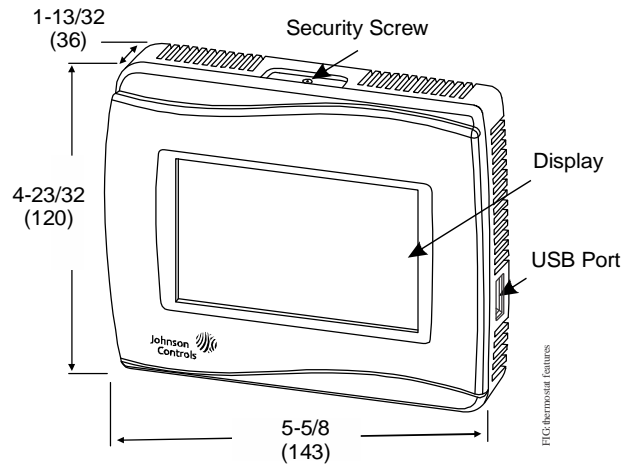

IMPORTANT: Only connect memory devices to the USB port. Do not use it for charging external devices.

Installing the Thermostat Controller

1. Use a 1/16 in. (1.5 mm) Allen wrench or Johnson Controls® T-4000-119 Allen-Head Adjustment Tool (order separately) to remove the security screw if it is installed on the top of the thermostat controller cover as illustrated in Figure 2.
2. Pull the top edge of the cover and open the thermostat controller as illustrated in Figure 2.

IMPORTANT: The cover is not secured on the bottom. Be careful not to drop the cover.

IMPORTANT: If you are installing more than one thermostat controller, keep track of which cover attaches to which base.

IMPORTANT: Use proper Electrostatic Discharge (ESD) precautions during installation and servicing to avoid damage to the electronic circuits of the thermostat controller.

Figure 2: Removing the Security Screw from the Thermostat Controller Cover (shown without Occupancy Sensor) (Left) and Removing the Thermostat Controller Cover (Right)

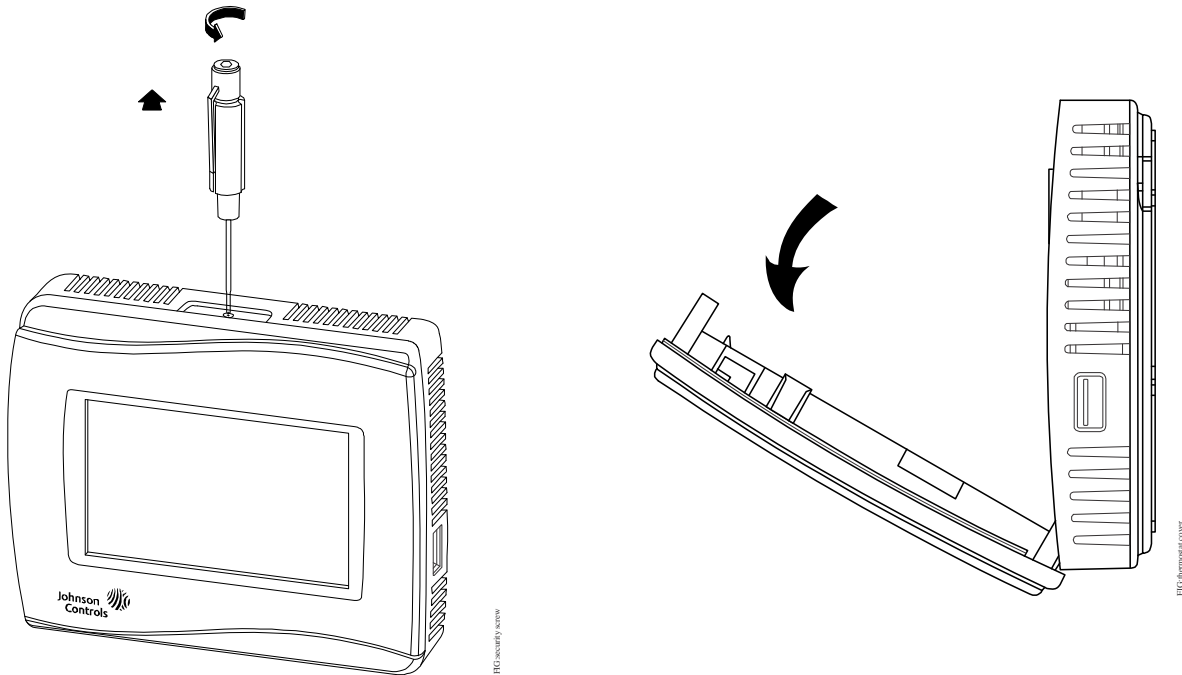

3. Align the thermostat controller mounting base on the wall with the security screw on the top and use the base as a template to mark the two mounting hole locations.

Notes:

- If you need to install the thermostat controller on an electrical junction box, use 2-1/2 x 4 in. (63 x 101 mm) square boxes with mud ring covers and avoid smaller 1-1/2 x 4 in. (38 x 101 mm) square or 3 x 2 in. (76 x 51 mm) boxes. This procedure ensures that you have enough space for cabling, if needed.
 - For surface-mounted applications, use durable mounting hardware, such as wall anchors, that cannot be easily pulled out of the mounting surface.
4. Pull approximately 6 in. (152 mm) of wire from the wall and insert the wire through the center hole in the thermostat controller mounting base. See Figure 3.
 5. Secure the mounting base to the wall surface using two mounting screws (user supplied) as illustrated in Figure 3.

Note: Be careful not to overtighten the mounting screws.

Figure 3: Mounting Hole Locations, Dimensions, in. (mm) (Left) and Securing the Thermostat Controller Mounting Base to the Wall (Right)

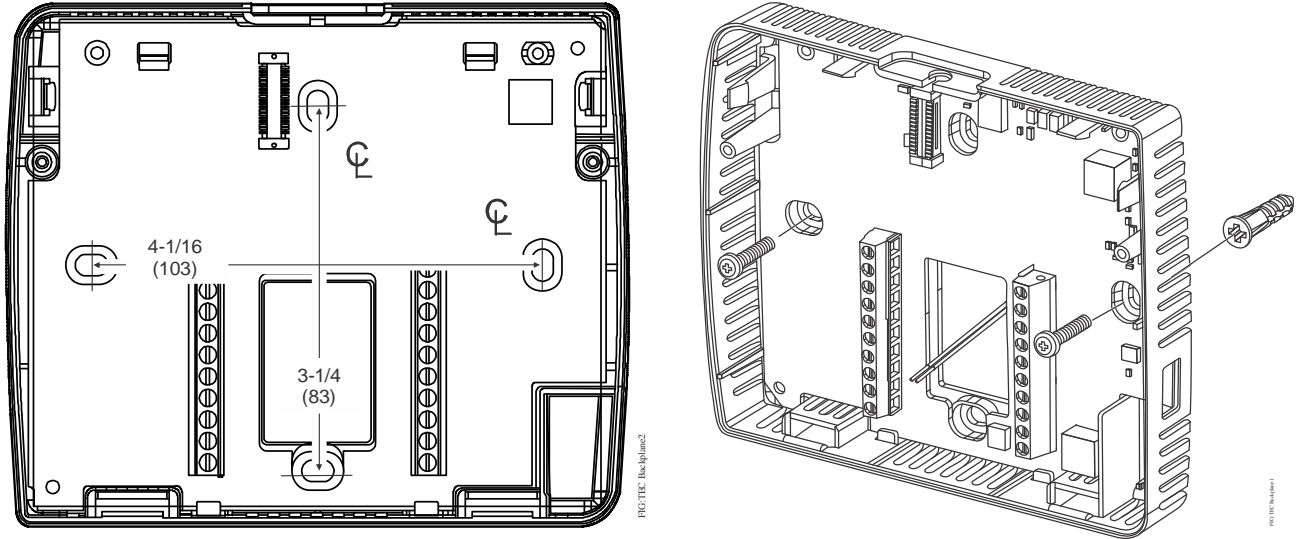

Wiring

When an existing thermostat controller is replaced, remove and label the wires to identify the terminal functions.

CAUTION

Risk of Electric Shock.

Disconnect the power supply before making electrical connections to avoid electric shock.

ATTENTION

Risque de décharge électrique.

Débrancher l'alimentation avant de réaliser tout raccordement électrique afin d'éviter tout risque de décharge électrique.

NOTICE

Risk of Property Damage.

Do not apply power to the system before checking all wiring connections. Short circuited or improperly connected wires may result in permanent damage to the equipment.

NOTICE

Risque de dégâts matériels.

Ne pas mettre le système sous tension avant d'avoir vérifié tous les raccords de câblage. Des fils formant un court-circuit ou connectés de façon incorrecte risquent d'endommager irrémédiablement l'équipement.

IMPORTANT: Make all wiring connections in accordance with local, national, and regional regulations. Do not exceed the electrical ratings of the TEC3000 Series Thermostat Controller.

IMPORTANT: Use proper ESD precautions during installation and servicing to avoid damage to the electronic circuits of the thermostat controller.

To wire the thermostat controller:

1. Strip the ends of each wire 1/4 in. (6 mm) and connect them to the appropriate screw terminals as indicated in Table 2 and Figure 7.

Note: For more details on wiring the MS/TP Communications Bus, refer to the *TEC3000 Series and Field-Selectable BACnet® MS/TP or N2 Networked Thermostat Controllers (LIT-12011956)*.

2. Carefully push any excess wire back into the wall.

Note: Seal the hole in the wall with fireproof material to prevent drafts from affecting the ambient temperature readings.

3. Reattach the communication wires to the terminal block.

Note: If multiple wires are inserted into the terminals, be sure to properly twist the wires together before inserting them into the terminal connectors.

4. Set the bus end-of-line (EOL) termination switch to the desired location on the TEC3620-00-000, TEC3621-00-000, TEC3622-00-000, and TEC3623-00-000 models only.

The bus EOL termination switch allows you to designate the thermostat controller as the end of the Field Controller (FC) Bus and N2 Bus. The default position is OFF. If the thermostat controller is at the end of a daisy chain of devices on the FC Bus and N2 Bus, set the EOL switch to the ON position. See Figure 4.

Figure 4: EOL Switch Position (Left) and Installing the Thermostat Controller Cover (Right)

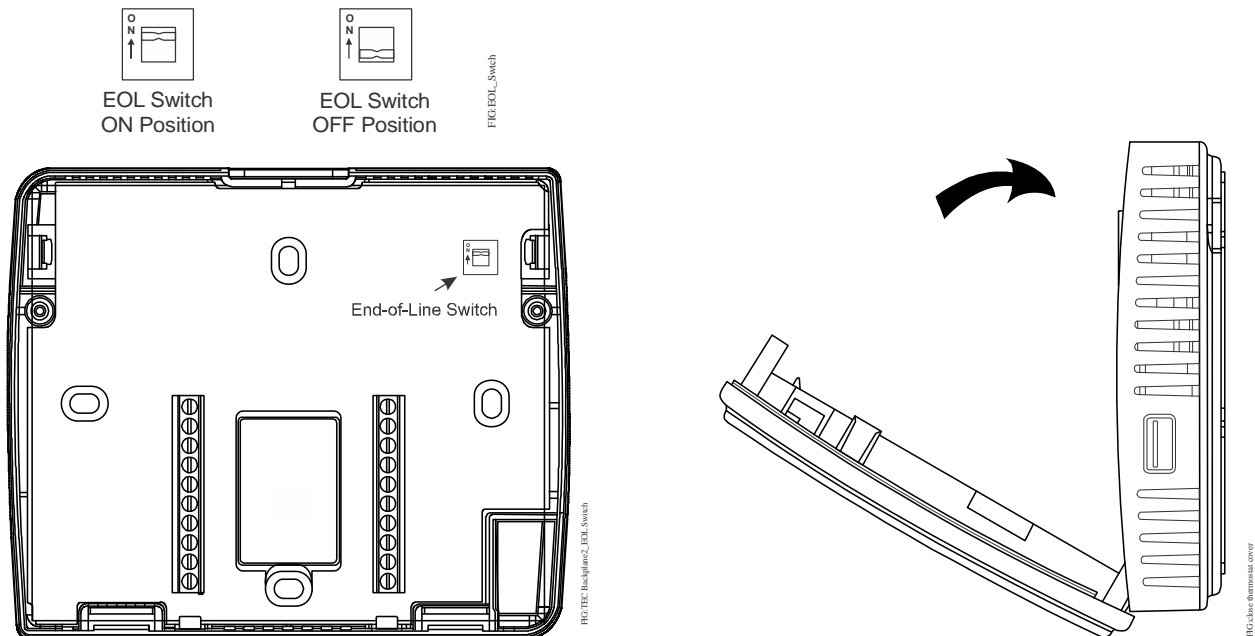

5. Reattach the thermostat controller cover to the mounting base (bottom side first).

IMPORTANT: Make sure you reattach the cover that corresponds to its correct base. The CPU board number needs to match the base board number. Otherwise, an operation error occurs after you reattach a cover and base that do not belong together (as shown in Figure 5). See Table 1 for TEC3000 model names and code numbers.

Figure 5: Error Code Indicating Mismatched Boards

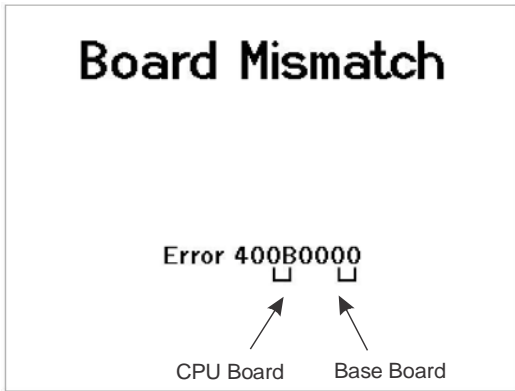

Table 1: TEC3000 Model Names and Code Numbers

Name	Code Number ¹	Name	Code Number ¹
TEC3310	00	TEC3610	0A
TEC3311	01	TEC3611	0B
TEC3312	02	TEC3612	0C
TEC3313	03	TEC3613	0D
TEC3320	04	TEC3620	0E
TEC3321	05	TEC3621	0F
TEC3322	06	TEC3622	10
TEC3323	07	TEC3623	11
TEC3330	08	TEC3630	12
TEC3331	09	TEC3631	13

1. The two-character code number is listed within the error code to indicate that the CPU board and base board do not belong together. However, if the same code number appears as both the CPU board and base board, there is no error. For example, if 0B is listed as the CPU board and the base board, the model is the TEC3611.

- Use a 1/16 in. (1.5 mm) Allen wrench or Johnson Controls T-4000-119 Allen-Head Adjustment Tool (order separately) to reinstall the security screw on the top of the thermostat controller cover.
- Remove the protective plastic cover sheet from the display.

IMPORTANT: If the display is dirty, **gently** wipe it clean with isopropyl alcohol or ethyl alcohol. Do not scrub hard as to avoid damaging the surface. Do not use other cleaners such as water, ketones, and aromatic solvents, since they may damage the polarizer.

Figure 6: Installing the Security Screw from the Thermostat Controller Cover (Shown without Occupancy Sensor)

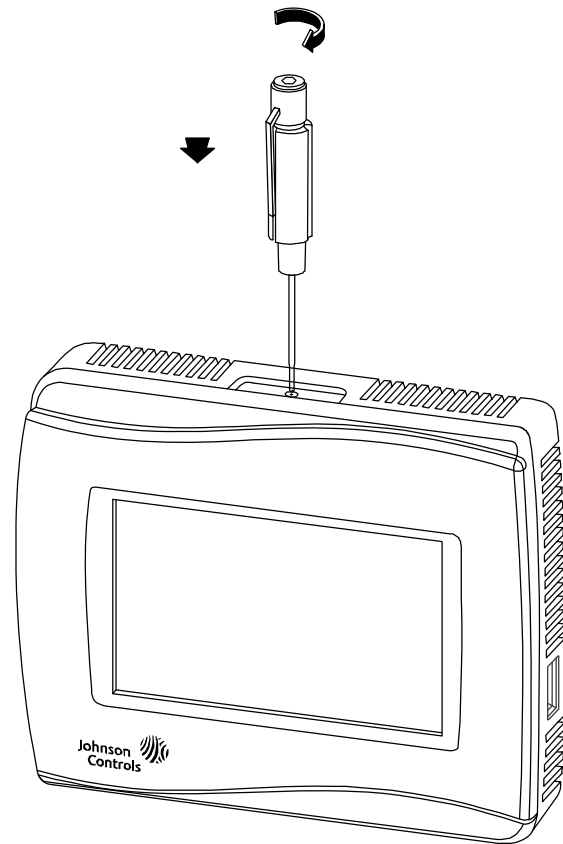

Table 2: Terminal Identification (See Figure 7 for Wiring Diagram)

Terminal Label	Function	
	TEC3320, TEC3321, TEC3322, TEC3323, Proportional FC/VAV	TEC3620, TEC3621, TEC3622, TEC3623 Proportional FC/VAV
24 V	24 VAC hot from transformer	
FAN H	Fan high	
FAN M	Fan medium	
FAN L	Fan low and fan on	
AUX	Auxiliary binary output	
AUX	Auxiliary power	
COM¹	24 VAC common from transformer	
CLG	Cooling command (configurable 0 to 10 V range)	
NC	No connection	
HTG	Heating command (configurable 0 to 10 V range)	
COM¹	Common	
VSF	Variable speed fan command (configurable 0 to 10 V range)	
BI2	Configurable binary input 2	
BI1	Configurable binary input 1	
COS	Changeover sensor	
R SEN	Zone temperature sensor	
NET+	Not connected	Field bus+ /N2+
NET-	Not connected	Field bus- /N2-
NET COM	Not connected	Isolated common for field bus

1. The common terminals, which do not include NET COM, are internally connected and can be used for all inputs and outputs.

Note: Only one transformer is required for each TEC.

Figure 7: Proportional Wiring Diagram (See Table 2 for Terminal Identification)

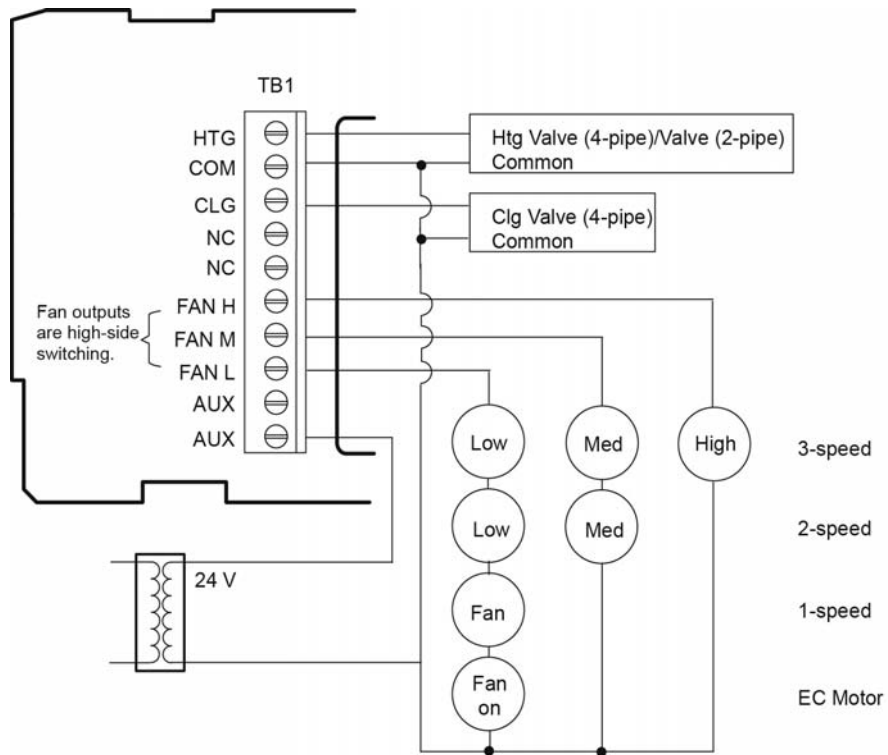

FIG-MkMod 2 Wiring_input

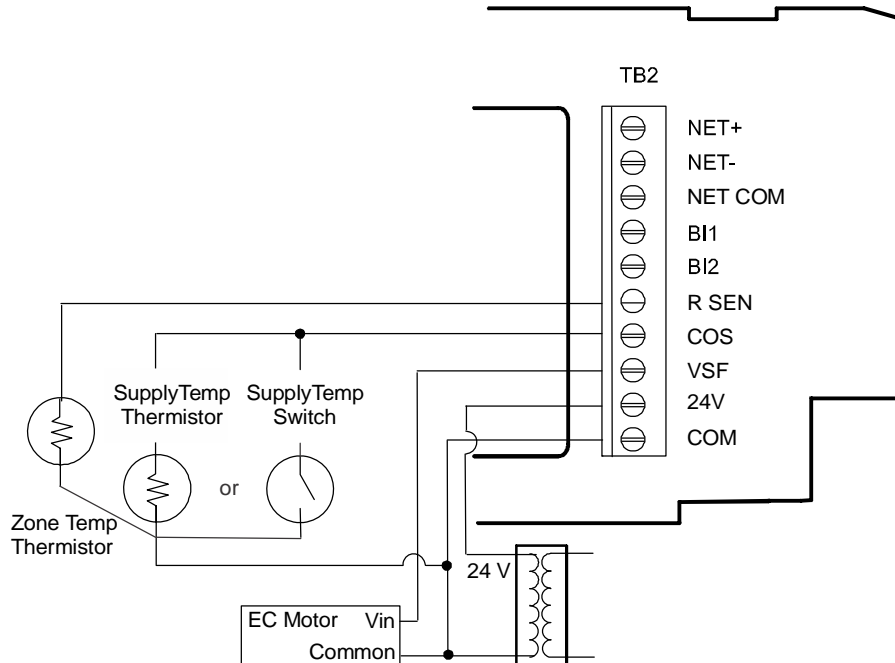

FIG-MkMod 2 Wiring_output

Note: VAV and 2-pipe systems should connect their valve to the heating output.

Figure 8: Proportional 0 to 10 VDC Control (Pressure-Dependent VAV)

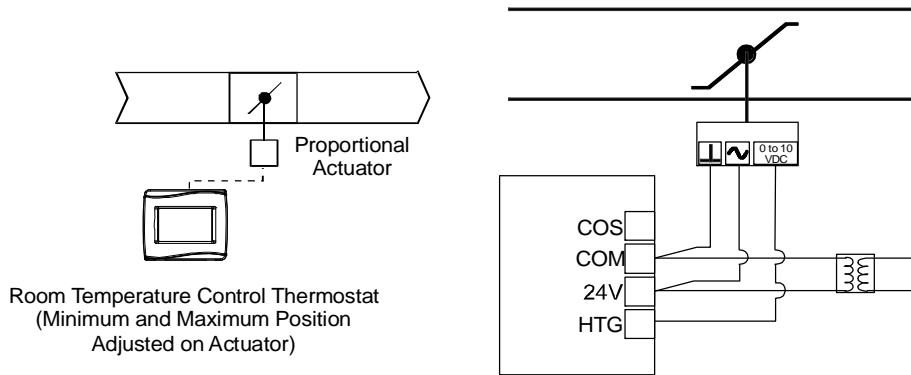

Figure 9: Proportional 0 to 10 VDC Control (Pressure-Dependent VAV with Changeover Sensor/Switch)

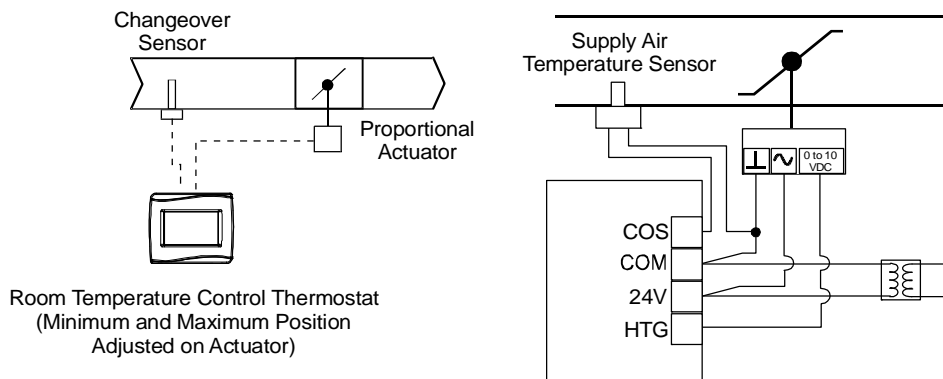
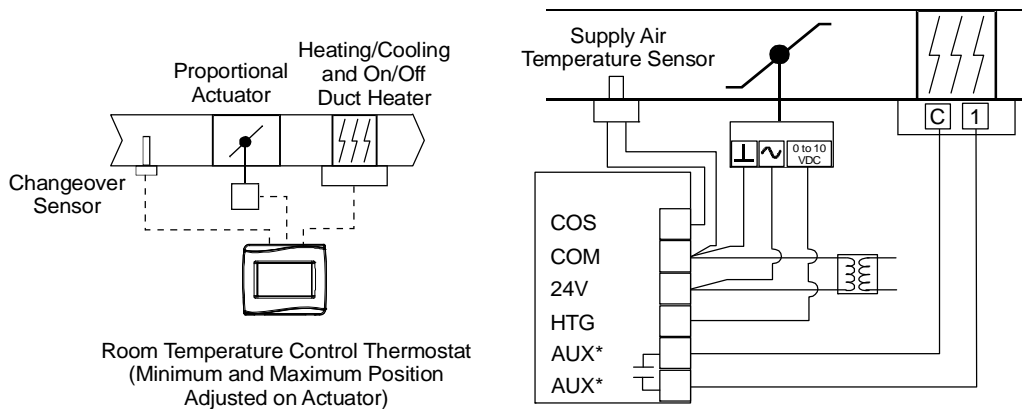

Figure 10: Proportional 0 to 10 VDC Control (Pressure-Dependent VAV with Changeover Sensor/Switch and Reheat)



*The Reheat Installed parameter must be set to True.

Note: Power to the AUX contact comes from the reheat coil.

Note: VAV and 2-pipe systems should connect their valve to the heating output.

Figure 11: Floating Control Two-Pipe Heating and Cooling Hydronic Valve Control Fan Coil Application

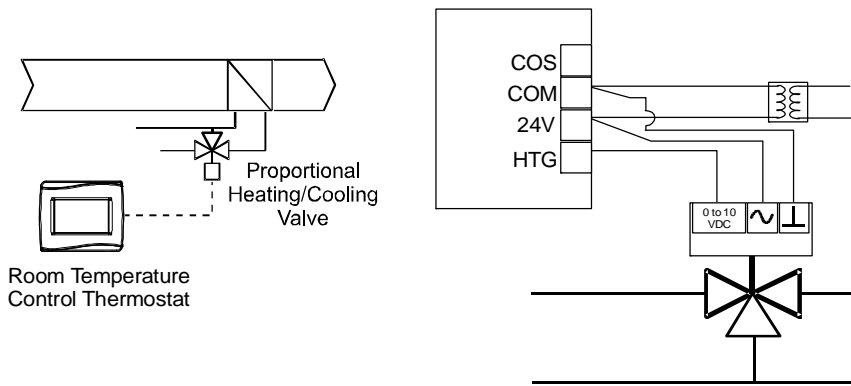

FIG:model_2_img_chng_valve

Figure 12: Floating Control Two-Pipe Heating and Cooling Hydronic Valve Control with Changeover Fan Coil Application

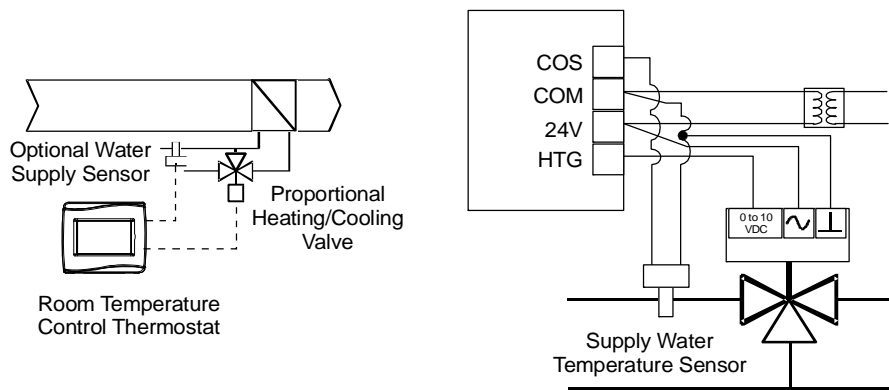

FIG:model_2_img_chng_valve_chngvr

Figure 13: Proportional 0 to 10 VDC Control (Two-Pipe and Four-Pipe Fan Coil Applications)

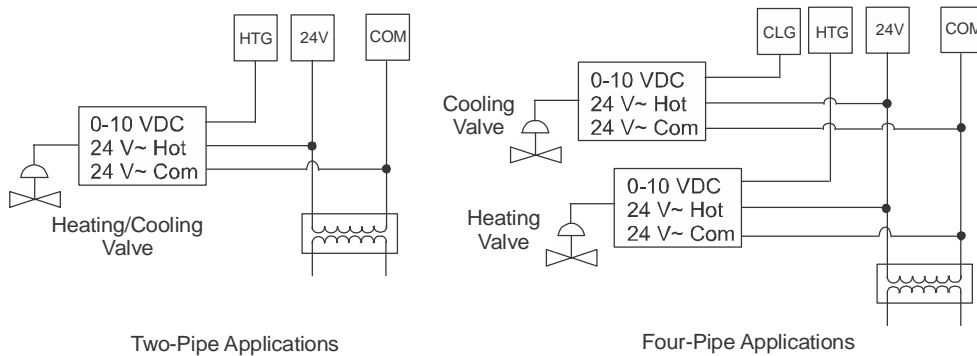

FIG:model_2_proportional

Figure 14: AUX Contact Wiring

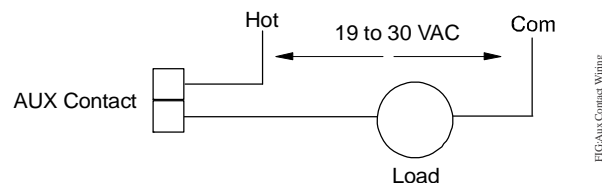
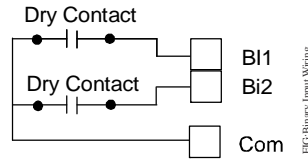

FIG:Aux Contact Wiring

Figure 15: Binary Input Wiring



Setup and Adjustments

IMPORTANT: Table 10 provides a full list of TEC3000 menu settings. In the upcoming sections, step-by-step instructions are included on how to access and adjust the more commonly used menus.

Overview

Figure 16 shows the thermostat controller home screen. You can customize it to show or hide various elements from the occupant. See Table 3 for a listing of the touchscreen icons and Table 10 to identify the home screen settings under the Display Settings. When screen customization is used in conjunction with a passcode, the building owner can control which options the occupant can access and adjust.

IMPORTANT: If lockout levels are used, some icons are hidden. Table 4 provides details of these levels.

Figure 16: Thermostat Controller Home Screen

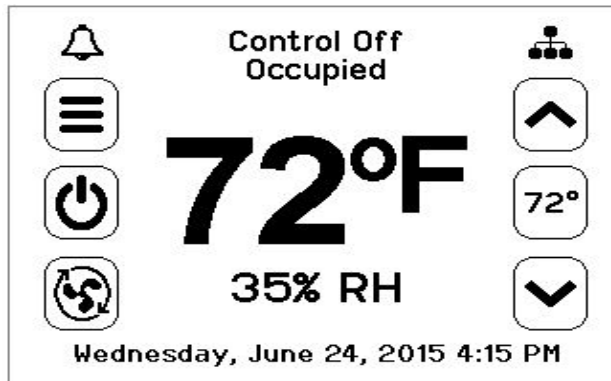

The humidity level appears on the home screen if there is a humidity sensor in the unit, or if the thermostat controller has a network override written to it.

Customizing the Home Screen

Customizing the Home screen settings include:

- Brightness
- Enable Backlight
- Units
- Time
- Time Zone
- Time Format
- Date
- Date Format

You can also show or hide these items on the Home screen:

- Fan Button
- Space Temperature
- Humidity
- Off Button
- Hold Button
- Setpoint
- Alarm Indication
- Occupancy Status
- Unit Status
- Date/Time

To customize the Home screen:

1. Press the **Menu** icon.
2. Press **Display Settings**.

3. Enable or disable elements of the home screen as appropriate for the building owner and occupants.
4. Set the passcode on the thermostat controller to prevent the occupants from changing settings that they should not have access to change.

Touchscreen Icons

Table 3 describes the home screen touchable icons. Press and release a touchscreen icon to activate the TEC. Additional touchable icons appear based on the menu, and those icons are also described in Table 3.

Table 3: Touchscreen Icons (Part 1 of 3)











Icon	Icon Name	Description
	Menu	Displays the configuration screens where various settings may be adjusted.
	Alarm	Indicates that the thermostat controller has triggered an alarm.
 	Unit Power On Off	Powers the thermostat controller on or off. Note: This icon disables all equipment control, but does not physically power down the unit.
	Network Communication	Indicates that the thermostat controller detected a supervisory controller and both are online.
 	Arrow	Increases or decreases a value depending on the configuration screen.
	Run/Hold	Displays the current setpoint. Hold mode is enabled by pressing the button.
	No Hold/Hold	Displays the current setpoint. Hold mode is not enabled.
	Hold/Hold	Displays the active setpoint. Hold mode is not enabled.
	Right Arrow	Proceeds to the next screen.

Table 3: Touchscreen Icons (Part 2 of 3)











Icon	Icon Name	Description
	<p>Fan Overrides for Single-speed Fans</p> <p>On</p> <p>Auto</p> <p>Quiet</p>	Adjusts the fan override between On, Auto, and Quiet for single-speed fans.
	<p>Fan Overrides for Variable-speed Fans</p> <p>On</p> <p>Auto</p> <p>Quiet</p>	Adjusts the fan override between On, Auto, and Quiet for variable-speed fans.
	<p>Fan Overrides for Multi-speed Fans</p> <p>Low</p> <p>Medium</p> <p>High</p> <p>Auto</p> <p>Quiet</p>	Adjusts the fan override between Low, Medium, High, Auto, and Quiet for multi-speed fans.
	Home	Returns the display to the main home screen.
	Back	Returns to the previous screen.
	Save	Saves the current configuration and parameter settings.
	Delete	Deletes the scheduled event.

Table 3: Touchscreen Icons (Part 3 of 3)

Icon	Icon Name	Description
	Clear	Clears the password entry on the keypad screen.
	Wrench	Indicates that the value is editable.
	Checkmark	Indicates that an event or schedule is programmed for a specific day of the week.
	Exclamation Point	Indicates that an error has occurred.

User Lockout

You can select from three different levels of access at the local display to manage functionality through the supervisory controller. This lockout is independent of any display or passcode settings. The existing temporary occupancy capability is unaffected by this feature. User lockout hides the icons that are not operable. The lockout levels are described in Table 4.

Table 4: User Lockout Levels

Lockout Level	Capability
State 0	Allows full access to Home Screen Display Adjustments and icons (default).
State 1	Hides the Menu icon.
State 2	Only allows the screen to trigger temporary occupancy. Menu, Unit Power, the Up and Down arrows, and Run/Hold are hidden.

Using the USB Port

The USB port allows you to quickly and easily load firmware upgrades, backup settings, and restore settings to the TEC3000 by using a USB drive. The TEC3000 can recognize eight configuration files or firmware package files. The USB drive format must be FAT or FAT32. The drive cannot be NTFS or USB 3.0. If you are upgrading firmware or copying configuration files, you need the TEC3000 passcode, if it has been set up. Do not remove the USB drive until the firmware upgrade is complete. The TEC3000 may restart and go offline to the NAE after a firmware upgrade. The upgrade takes approximately three minutes.

Configurations are copied, except for the Communication mode. See [*Choosing the Communication Mode \(TEC3620-00-000, TEC3621-00-000, TEC3622-00-000, and TEC3623-00-000 Models\)*](#) to configure each device.

Loading the Firmware

1. Ensure that the TEC screen is on.
2. Insert the USB drive into the right side of the TEC.
See Figure 1 for the USB port location.
3. Press the **Menu** icon.
4. Scroll down the menu and press **Update**.
5. Press **Load Firmware**.
6. Select the correct firmware version. The correct file name has the .pkg extension.
7. Press **Confirm** if you have the correct firmware version.

The firmware is loaded from the USB drive into the TEC3000 operating system. The TEC3000 locates the new firmware only if the new firmware is on the root drive of the USB drive. See [*Troubleshooting*](#) if the firmware is not loaded correctly.

8. Remove the USB drive from the TEC3000 controller when the update is complete.

The TEC3000 firmware update is complete when the TEC3000 restarts and returns to the home screen.

Backing Up the Settings

1. Ensure that the TEC screen is on.
2. Insert the USB drive into the right side of the TEC.

See Figure 1 for the USB port location.

3. Press the **Menu** icon.
4. Scroll down the menu and press **Update**.
5. Press **Backup**.

A message appears stating that the file is saved locally and on a USB drive.

6. Press **Confirm to save locally and on USB**.

The setting files are named based on the TEC3000 model name, date, and time stamp (for example, TEC3311-00_2015-10-08T1). The files are saved locally and on the USB drive's root directory. See [Troubleshooting](#) if the settings are not backed up correctly.

7. After the settings are saved onto the USB drive, remove the USB drive from the TEC3000.

Restoring the Settings

1. Ensure that the TEC screen is on.
2. Insert the USB drive into the right side of the TEC.

See Figure 1 for the USB port location.

3. Press the **Menu** icon.
4. Press **Update**.
5. Press **Restore**.

6. Select Local Storage or the correct configuration file created from a previous backup operation.

The setting files are named based on the TEC3000 model name, date, and time stamp (for example, TEC3311-00_2015-10-08T1). The files are saved locally and on the USB drive's root directory.

7. Press **Confirm** if you have the correct file name.

The settings are loaded from the USB drive.

8. After the settings are loaded from the USB drive, remove the USB drive from the TEC3000.

Choosing the Communication Mode (*TEC3620-00-000, TEC3621-00-000, TEC3622-00-000, and TEC3623-00-000 Models*)

1. Ensure the TEC screen is on.
2. Press the **Menu** icon.
3. Press **Network Setup**.
4. Press **FC Comm Mode**.

5. Select BACnet or N2 by pressing  .



6. Proceed to Step 7 to perform BACnet communication and Step 15 to perform N2 communication.

7. Press  to return to the previous screen.

8. Press **BACnet Instance ID**.
9. Enter the unique BACnet instance ID through the keypad.
10. Press **Save**.
11. Press  to return to the previous screen.
12. Press **BACnet Address**.
13. Enter the BACnet MS/TP address through the keypad.
14. Press **Save**.
15. After selecting N2 in Step 5, press **Save**.

16. Press  to return to the previous screen.
17. Press **N2 Address**.
18. Enter the N2 address through the keypad.
19. Press **Save**.

Configuring the Thermostat Controller

Use the Menu icon on the home screen to access and change the basic operating parameters of the thermostat controller. During normal operation, press the **Menu** icon once to access the following parameters:

- Faults Status
- Display Settings
- Equipment Setup
- Controller Information
- Setpoints
- Control Setup
- System Status
- Commissioning
- Schedule
- Network Setup
- Control Status
- Update

Installer Configuration Menu

The thermostat controller comes from the factory with default settings for all configuration parameters. The UI menu navigation and default settings are shown in Table 10. Before any outputs turn on, the controller must be configured for the equipment connected. You need to start from the home screen to perform any of the following tasks.

Screen Reset

The current screen returns to the home screen if the current screen is not touched for 3 minutes.



Selecting the Unit Type

There are three unit types. They are:

- 4-pipe—This unit type has both heating and cooling coils plus a supply fan. This configuration can also be used on configurations that are heating or cooling only.
- 2-pipe—This unit type has a single set of pipes that can serve hot or chilled water plus a supply fan. The Supply Temp Type allows for the connection of an analog sensor or an aquastat to a binary input. Based on the water temperature or aquastat state, the unit controls heating or cooling.
- VAV—This unit type is designed for a pressure-dependent zone damper and the supply fan outputs are disabled. The TEC senses the supply air temperature coming from the unit. The Supply Temp Type setting allows for the connection of an analog sensor or binary duct thermostat. Based on the air temperature or duct thermostat state, the zone damper controls for heating or cooling. The TEC does not control the unit delivering the air. The logic needs to be part of another controller.

By default, the thermostat controller is configured for 4-pipe fan coil mode. To change to a 2-pipe or Pressure-Dependent VAV mode:



1. Press the **Menu** icon.

2. Press **Equipment Setup**.
3. Press **General**.
4. Press **Unit Type** and select **2-pipe, 4-pipe, or VAV**.
5. Press  to save and  to return to the previous screen.



Note: Selecting VAV reboots the controller in order to apply the change.

Configuring the Supply Fan - Fan Coil Only

On fan coil units (2-pipe or 4-pipe), three different types of supply fans are supported. These are single-speed fans, multi-speed fans (up to three discrete speeds), and VSF using a 0 to 10 V control signal and an optional binary on/off command. Note that fan control is not available when in VAV mode. To select the fan type:

1. Press the **Menu** icon.
2. Press **Equipment Setup**.
3. Press **Supply Fan**.
4. Press **Supply Fan Type** and select **Single Speed, Multi-Speed, or Variable Speed**.
5. Press  to save and  to return to the previous screen.

For multi-speed fan control, you can adjust the point when the medium or high speed turns. The fan speed is based on the load on the cooling/heating device, and is a percentage between 0 and 100. By default, the Med Speed On Cmd is 33% and the High Speed On Cmd is 66%. When only two fan speeds are used, you must set the High Speed On Cmd to 100% to disable the third speed and set the Med Speed On Cmd to 50%. To adjust these values:



1. Press the **Menu** icon.
2. Press **Equipment Setup**.
3. Press **Supply Fan**.
4. Press **Medium Speed On Cmd** and adjust accordingly.
5. Press **High Speed On Cmd** and adjust accordingly.
6. Press  to save and  to return to the previous screen.

For VSF control, the output is configurable for any range between 0 V and 10 V. The parameters are Start Voltage, Full Speed Voltage, and Minimum Command. Start Voltage is the voltage output at which the fan begins running, and Full Speed Voltage is the voltage output at which the fan reaches full speed. Minimum Command is the percentage of the range between the Start Voltage and the Full Speed Voltage. The fan does not go below the minimum command when the fan is turned on. By default, the Start Voltage is 2 V, the Full Speed Voltage is 10 V, and the Minimum Command is 20%.

When the variable speed fan is off, the FAN binary output is off and the voltage at the VSF output is 0 V. When the fan turns on, the FAN binary output turns on and the voltage at the VSF output begins controlling the fan. When the VSF is configured for reverse acting mode (Start Voltage is above Full Speed Voltage), the VSF output goes to the lesser of 10 V and 1 V above the Start Voltage when the fan is turned off.



To configure the variable speed parameters:

1. Press the **Menu** icon.
2. Press **Equipment Setup**.
3. Press **Supply Fan**.

4. Press **Start Voltage** and adjust accordingly.
5. Press **Full Speed Voltage** and adjust accordingly.
6. Press **Minimum Command** and adjust accordingly.
7. Press  to save and  to return to the previous screen.

Setting the Control Mode

The Control Mode informs the controller to either run in Cooling only, Heating only, or Automatic mode, based on the temperature in the zone relative to the heating and cooling setpoints. Control Mode does not override equipment lockouts or changeover. To set the Control Mode:

1. Press the **Menu** icon.
2. Press **Control Setup**.
3. Press **General**.
4. Press **Control Mode** and select **Cooling**, **Heating**, or **Auto** as desired.
5. Press  to save and  to return to the previous screen.

Setting the Fan Mode - Fan Coil Only

The Fan Mode informs the controller how to handle the fan. There are two options for fan configuration: a Fan Mode available to the installer through the menu system, and a fan override available as an option to the end user from the Fan icon on the home screen. See [Customizing the Home Screen](#) for information on enabling and disabling end-user controls. The Fan Mode available to the installer is dependent on the fan type. The following options are provided for single- and variable-speed fans:

- On—Fan is continuously on
- Auto—Fan cycles on demand with the controller entering cooling, heating, or dehumidification modes
- Smart—Fan cycles on demand with the controller entering cooling or heating modes during unoccupied periods but is continuously running during occupied and standby periods

The following Fan Mode options are provided for multi-speed fans:

- Low—Fan is continuously on low
- Medium—Fan is continuously on medium
- High—Fan is continuously on high
- Auto—Fan cycles on demand with the controller entering cooling, heating, or dehumidification modes
- Smart—Fan cycles on demand with the controller entering cooling or heating modes during unoccupied periods but is continuously running during occupied and standby periods

The Fan Override icon on the home screen is dependent on the fan type. The following options are provided for single- and variable-speed fans:



- On—Overrides the fan to be continuously on
- Auto—Follows the behavior set as Fan Mode
- Quiet—Follows the behavior set as Fan Mode, but prevents the fan from ever going above minimum speed. The Quiet option has no effect on equipment with single-speed fans

The following Fan Override options are provided for multi-speed fans:

- Low—Fan is continuously on low
- Medium—Fan is continuously on medium

- High—Fan is continuously on high
- Auto—Follows the behavior set as Fan Mode
- Quiet—Follows the behavior set as Fan Mode, but prevents the fan from ever going above minimum speed



To set the Fan Mode:

1. Press the **Menu** icon.
2. Press **Control Setup**.
3. Press **General**.
4. Press **Fan Mode** and select **On, Auto, or Smart**.
5. Press  to save and  to return to the previous screen.

Configuring the Zone Space or Equipment Size

By default, the TEC3000 is configured to have a slower temperature response for larger zones with normal-sized equipment. In installations with small zones and oversized equipment, set the Equipment Size parameter to Oversized.

To set the Equipment Size parameter:

1. Press the **Menu** icon.
2. Press **Control Setup**.
3. Press **Tuning**.
4. Use the up and down arrows to navigate to **Equipment Size**.
5. Press **Equipment Setup** and select **Oversized**.
6. Press  to save and  to return to the previous screen.

Changeover

Pressure-Dependent VAV systems and 2-pipe fan coils require changeover detection in order to switch seasonal operation between heating and cooling modes. The TEC supports the following methods for changeover: automatic changeover using an analog sensor (thermistor), automatic changeover using a binary switch, or remote changeover from a BAS and manual changeover.

For automatic changeover, a supply temperature sensor or switch must be connected to the COS input of the TEC. Changeover Mode must be set to Auto, and Supply Temp Type must be set for Analog Sensor, Cooling N.C. (cooling when switch is closed), or Heating N.C. (heating when switch is closed). When an analog sensor is used, the changeover setpoint can be adjusted. The changeover logic applies a 10-degree Fahrenheit differential to the setpoint. The system switches to cooling mode when the temperature drops below the changeover setpoint and remains in cooling mode until the measured temperature has risen 10 degrees above the changeover setpoint.

To configure automatic changeover:

1. Press the **Menu** icon.
2. Press **Equipment Setup**.
3. Press **Changeover**.
4. Press **Changeover Mode** and select **Auto**.
5. Press **Supply Temp Type** and select **Analog Sensor, Cooling N.C., or Heating N.C.**
6. If using an Analog Supply Temp Sensor, press **Supply Temp Type** and adjust accordingly.

7. Press  to save and  to return to the previous screen.

Additionally, the thermostat controller supports manual changeover. To configure manual changeover:

1. Press the **Menu** icon.
2. Press **Equipment Setup**.
3. Press **Changeover**.
4. Press **Changeover Mode** and select **Heating** or **Cooling**.

5. Press  to save and  to return to the previous screen.

You need to ensure that the Supply Temp type is set to Analog Sensor. The Changeover Mode is also exposed to the BAS through the CGOVR-MODE and can be commanded from the BAS.

On 2-pipe/VAV systems without an automatic changeover, or on 4-pipe systems, you can use COS as a monitor-only point for reading an analog sensor. By setting the controller in 4-pipe mode, or selecting Heating or Cooling for Changeover Mode, the controller defaults to monitor-only mode for the COS and exposes the value to the network as the supply temperature.

Dehumidification Control - Fan Coil Only

The TEC3000 controller support dehumidification control on fan coil devices under three configurations:

- 4-pipe fan coil
- 4-pipe fan coil with reheat
- 2-pipe fan coil (with changeover in cooling mode) with reheat

For optimal dehumidification performance, a 4-pipe unit with floating/incremental or 0 to 10 V control and a multi-speed or variable-speed fan is recommended.

Dehumidification operates when the zone humidity increases above the zone humidity setpoint and the controller is in the Idle or Cooling state. Dehumidification does not operate during heating and stops if the zone temperature drops below the heating setpoint. When dehumidification is active, the cooling device controls to the humidity setpoint, and the heating device reheats the zone in order to keep the temperature at the cooling setpoint. While in the dehumidification mode, a multi-speed or variable-speed fan runs at the lowest possible speed to maximize condensation and moisture removal across the cooling coil.

To enable dehumidification control:

1. Press the **Menu** icon.
2. Press **Control Setup**.
3. Press **General**.
4. Press **Dehum Enable** and select **Yes**.

5. Press  to save and  to return to the previous screen.

This point is also exposed to the BAS through the point DEHUM-EN.

To adjust the dehumidification setpoint:



1. Press the **Menu** icon.
2. Press **Setpoints**.
3. Press **Dehumidification** and adjust accordingly.

4. Press  to save and  to return to the previous screen.

This point is also exposed to the BAS through the point DEHUM-SP.

Temperature Setpoints

The thermostat controller provides a flexible setpoint configuration to give power to the building owner while being easy to use by the occupant. In addition to a simple up/down offset adjustment on the home screen for the occupant, there are six temperature setpoints on the TEC. The six temperature setpoints are Cooling and Heating setpoints for Occupied, Unoccupied, and Standby modes. To set these setpoints:

1. Press the **Menu** icon.
2. Press **Setpoints**.
3. Select the setpoint to adjust and change as desired.
4. Press  to save and  to return to the previous screen.

Note: The TEC enforces a 2-degree deadband between heating and cooling setpoints. If a setpoint violates this standard (for example, cooling setpoint is set to 70 with a heating setpoint already set to 70), the opposing setpoint is modified to comply with this deadband (in the previous example, the heating setpoint would automatically change to 68).

The occupant has access to an up/down adjustment from the home screen. This adjustment applies a fixed offset (+/-) to the currently active setpoint, and this offset holds until the occupancy state of the controller changes. If the user taps the setpoint on the home screen, the icon inverts and displays white text on a black icon. The offset is held throughout all occupancy periods. For example, if the TEC is cooling in Occupied mode to an occupied cooling setpoint of 72 and you raise the setpoint 2 degrees to 74 from the home screen and then select **hold**, then the +2 degree offset persists through an occupancy change. If the occupancy then changes to unoccupied, with a setpoint of 80 degrees, the effective setpoint is 82 degrees. This allows the occupant to have a small amount of control over raising or lowering the temperature, but the building owner can still set back setpoints during standby and unoccupied periods. When the setpoint is in Hold mode, pressing the icon again releases the hold and immediately sets the setpoint offset back to 0.

When the TEC is in Min/Max mode (Setpoints/Occ Setpoint Select are equal to Min and Max Setpoint), the TEC rejects any attempts to change the present value outside of the valid range. If the present value is outside of the valid range (for example, if the Occ Setpoint Select is switched from Setpoint Offset to Min and Max Setpoint), the present value is reset to be in the center of the valid range.

The four modes of setpoint operation are described in Table 5.

Table 5: Setpoint Operation

Mode of Setpoint Operation	Details
Occ Setpoint Select = Setpoint Offset and Heat Cool Setpoint Mode = Individual Setpoints	This is the default mode and the original mode of operation that the TEC was released with (the next three modes are new). In this mode, the TEC has a heating setpoint and a cooling setpoint. There is a common Setpoint Offset (warmer/cooler adjust) that is applied to each setpoint simultaneously. The range of setpoint adjustment is two-fold: <ul style="list-style-type: none"> • There are large constant ranges bounding the individual heating and cooling setpoints. • There is also a smaller configurable range limit set to the Setpoint Offset point (Control Setup > General > Max Setpoint Offset).
Occ Setpoint Select = Min and Max Setpoints and Heat Cool Setpoint Mode = Individual Setpoints	In this mode, the TEC has a heating setpoint and a cooling setpoint. Each setpoint has a configurable range (Setpoints > Min Cooling Setpoint, Max Cooling Setpoint, Min Heating Setpoint, and Max Heating Setpoint). The configurable range values are bounded by the larger constant bounds used in Setpoint Offset mode and are constrained in the following manner: Min must be below Max and Heating must be below Cooling, so in order from least to greatest, the values are: Min Heating Setpoint, Max Heating Setpoint, Min Cooling Setpoint, and Max Cooling Setpoint.

Table 5: Setpoint Operation

Mode of Setpoint Operation	Details
Occ Setpoint Select = Setpoint Offset and Heat Cool Setpoint Mode = Common Setpoint	In this mode, the TEC has one setpoint, Common Setpoint, for heating and cooling. There is also a common Setpoint Offset (warmer/cooler adjust) that is only applied to Common Setpoint. Otherwise, this setting works the same as when Occ Setpoint Select = Setpoint Offset and Heat Cool Setpoint Mode = Individual Setpoints.
Occ Setpoint Select = Min and Max Setpoints and Heat Cool Setpoint Mode = Common Setpoint	In this mode, the TEC has one setpoint, Common Setpoint, for heating and cooling. There is a configurable range for Common Setpoint, Min Setpoint, and Max Setpoint.

Configuring Occupancy

The TEC3000 controller supports a wide variety of occupancy sources to adapt to nearly any application.

- Local stand-alone weekly scheduler
- Remote schedule from BAS
- Occupancy sensor (internal or remote)
- Occupancy binary input (configurable)
- Manual occupancy override
- Temporary occupancy (by interacting with screen while unoccupied)
- Temporary occupancy binary input

Occupancy is determined using a top-down decision matrix as shown in Table 6.

Enumerations may not match the *TEC3000 Series On/Off or Floating Fan Coil and Individual Zone Thermostat Controllers with Dehumidification Capability Installation Instructions (Part No. 24-10787-6)*, *TEC3000 Series Proportional Fan Coil and Individual Zone Thermostat Controllers with Dehumidification Capability Installation Instructions (Part No. 24-10788-0)*, *TEC3000 Series Single- or Two-Stage Economizer Thermostat Controllers Installation Instructions (Part No. 24-10789-5)*, and *TEC3000 Series Field-Selectable BACnet MS/TP or N2 Networked Thermostat Controllers Technical Bulletin (LIT-12011956)* for NAE releases prior to 7.x.

Table 6: Occupancy Determination

Sequence of Operation (Highest to Lowest Priority)					Status Indicated				
Manual Occupancy Mode (OCCOVRD-MODE)	Occupancy BI (BI1-S, BI2-S) ¹	Temporary Occupancy ^{2, 3}	Occupancy Schedule (External or Schedule) (OCC-CONFIG, NET-OCC)	Motion Sensor ⁴	Effective Occupancy (EFF-OCC)	Occupancy Source (OCCSOURCE-S)			
Occupied	–	–	–	–	Occupied-Override	Occ Override			
Unoccupied					Unoccupied-Override				
No Override	Closed ¹				Occupied	Occupancy BI			
	Open ¹				Unoccupied				
	Not Configured ¹		True ²	NOT Occupied		Temp Occupancy	Temp Occ		
			True ³	NOT Occupied		Temp Occupancy	Temp Occ BI		
			False		Occupied		True	Occupied	Occupancy Sensor
	False	Standby							
	Unoccupied						Disabled	Occupied	Occupancy Schedule
							Standby	Unoccupied	
	Not Set ⁵					True	Occupied	Occupancy Sensor	
						False	Unoccupied		
Disabled						Occupied	Occupancy Schedule		

1. Not Configured means that neither BI1 Config nor BI2 Config is set to Occupancy BI. Open and Closed refer to the current state of the BI when configured as Occupancy.
2. True is triggered by interacting with the screen during a scheduled unoccupied period. A value of True can only occur when the schedule is not Occupied.
3. When triggered by a BI configured for Temp Occ, the input is ignored when the schedule is Occupied, the Manual Occupancy Mode is **not** No Override, or an Occupancy BI is configured.
4. Built-in occupancy sensing (PIR) or EI configured for Motion NO or Motion NC.
5. Not Set occurs when no events are scheduled through the local scheduler, or the schedule source is set to Schedule and the Schedule is writing Not Set as the schedule.

Selecting Schedule Source

Scheduling

The TEC3000 thermostat controller can operate as a stand-alone unit with an internal schedule or scheduled with an external schedule. The OCC-CONFIG object sets the method used for scheduling.

If the OCC-CONFIG is set to External, the NET-OCC object is used to control the unit externally.

If the OCC-CONFIG is set to Schedule, the internal schedule commands the LOCAL-OCC object, which sets the Occupancy Schedule command.

Note: If you do not have a schedule in the Schedule object and you have the OCC-CONFIG set to Schedule, you can control the unit with the LOCAL-OCC object externally; however, we do not recommend this method. See Table 7 for scheduling information.



Once the Occupancy Schedule command is set, the effective occupancy is determined by settings shown in the Occupancy Determination table. See Table 6.

Table 7: BAS Objects for Scheduling

BAS Objects for Scheduling			
OCC-CONFIG	LOCAL-OCC (Commanded by Internal Schedule)	NET-OCC	Occupancy Schedule Command¹
External	Any State (Internal Schedule in Control)	Occupied	Occupied
		Unoccupied	Unoccupied
		Standby	Standby
		Not Set	Not Set
Schedule	Occupied	Not Applicable	Occupied
	Unoccupied		Unoccupied
	Standby		Standby
	Not Set		Not Set

1. The effective occupancy can be affected by other factors listed in Table 6.

The occupancy schedule comes from either the weekly scheduler built into the TEC or as an input from the BAS. The Schedule Source must be selected to tell the controller where to read the occupancy source from. To select the schedule source:

1. Press the **Menu** icon.
2. Press **Schedule**.
3. Press **Schedule Options**.
4. Press **Schedule Source** and select **Schedule** (Local) or **External** (BAS).
5. Press  to save and  to return to the previous screen.

This option is also exposed to the BAS through the point OCC-CONFIG. If BAS is configured as the occupancy source, map the point NET-OCC in and write to that point to control the schedule remotely. If the supervisor goes offline (as identified by the network icon going away on the home screen of the TEC), the control logic automatically falls back to the local schedule as the occupancy source. If that schedule is not set, the default occupancy is continuously occupied.

Setting the Local Schedule

A weekly occupancy schedule with up to four occupancy events for each day can be set locally on the TEC and operate independently of a supervisor. To set the schedule:

1. See [Selecting Schedule Source](#) to ensure the schedule source is set to Local.
2. Press the **Menu** icon.
3. Press **Schedule**.
4. Press **Set Schedule**.
5. Select the days to which the schedule should apply. Note that if events are already set for the selected days, they appear in the corresponding event box. If any events conflict between selected days, an asterisk appears in the event box. See Figure 17.
6. Select the event to be set. See Figure 18.

7. Set the Occupancy to Not Set, Occupied, Unoccupied, or Standby and press **Save**.

IMPORTANT: Internally, the TEC 3000 uses a BACnet schedule where daily schedules are independent of the previous and next days. The default occupancy of the TEC3000 from the factory is set to Occupied. As a result, a daily event at 12:00 AM must be scheduled if you do not want the controller to transition to Occupied Mode at midnight.

Figure 17: Selecting the Days (Left) and Selecting the Event (Right)

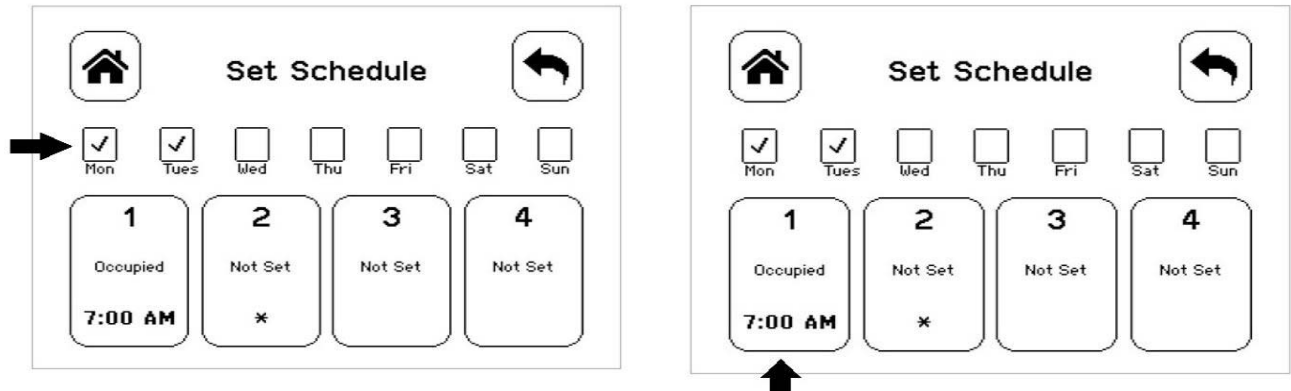
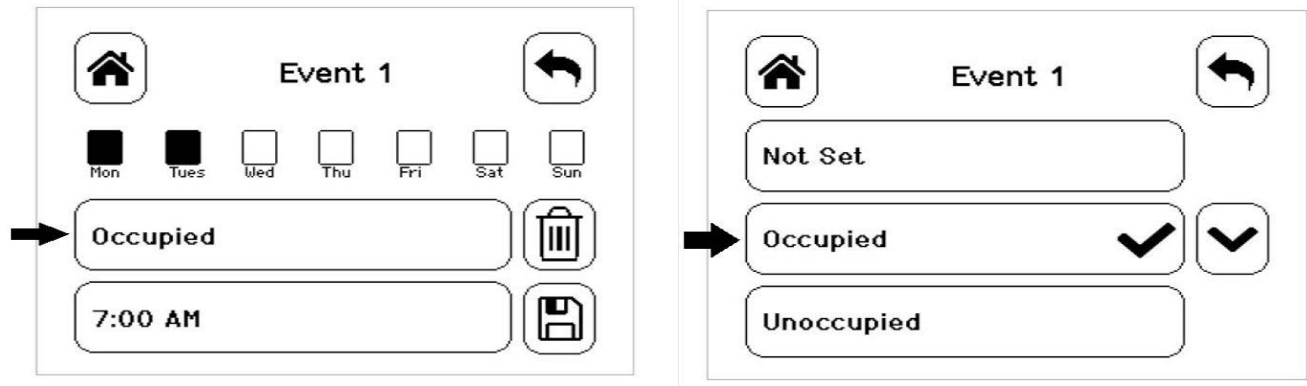
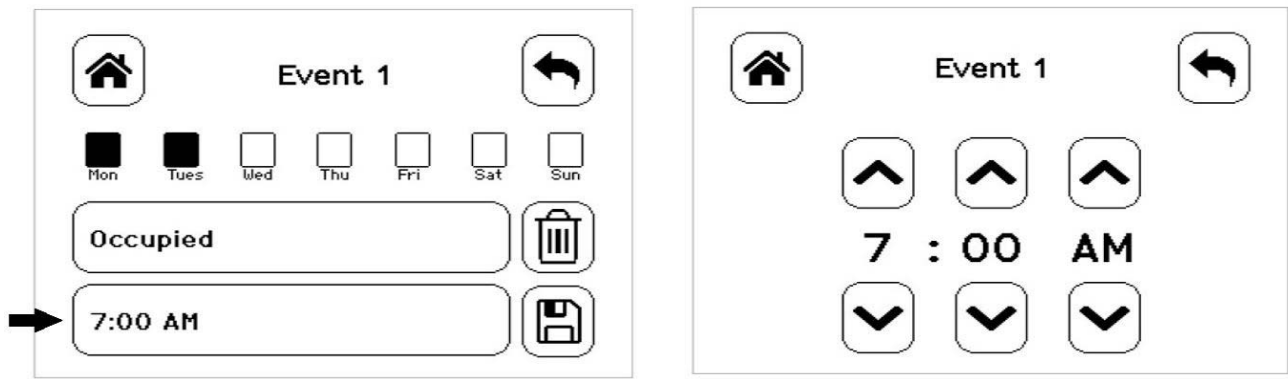

Figure 18: Setting the Room Occupancy (Left) and Setting the Occupancy Mode (Right)



8. Set the time to the time at which the event should occur and press **Save**.

Figure 19: Setting the Event Time (Left) and Viewing the Event Time (Right)



9. Press **Save** to save the event and press the **Return** icon to return to the main scheduler screen.

Figure 20: Returning to the Main Menu

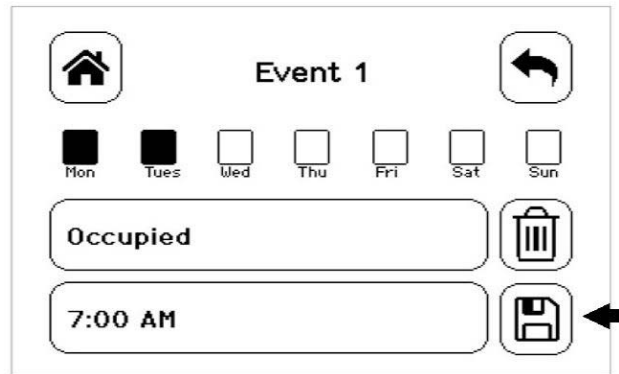

10. Press  to save and  to return to the previous screen.

Overriding the Occupancy Mode

The TEC supports a manual override of all other schedule sources (for example, Schedule, Occupancy BI, and temporary occupancy). To override the Occupancy Mode:

1. Press the **Menu** icon.
2. Press **Schedule**.
3. Press **Schedule Options**.
4. Press **Manual Occupancy Mode** and select **Occupied**, **Unoccupied**, or **No Override**.

5. Press  to save and  to return to the previous screen.



This option is also exposed to the BAS through the point OCCOVRD-MODE.

Enabling Optimal Start

The TEC supports an advanced optimal start algorithm. The algorithm works in conjunction with a local schedule to pre-heat or pre-cool the zone before scheduled occupancy periods begin, in order to bring the zone to the desired occupied setpoint when the scheduled occupancy period begins. Occupant comfort is ensured while automatically minimizing energy usage. This algorithm creates a model of the zone being controlled and automatically determines when to start the equipment before the scheduled transition to Occupied. The start time automatically adjusts daily to minimize the time between reaching setpoint and entering Occupied state.



Note: Optimal Start does not work when the schedule source is set to External.

To enable this feature:

1. Press the **Menu** icon.
2. Press **Schedule**.
3. Press **Schedule Options**.
4. Press **Optimal Start Enable** and select **Yes**.
5. Press  to save and  to return to the previous screen.

Enabling the Motion Sensor (TEC3x21-00-000, TEC3x23-00-000 Models)



By default on models with integral motion sensing capability, the motion sensor is enabled with a default timeout of 15 minutes from the last detection of motion in the zone. On models without an integrated sensor, the default timeout is still 15 minutes, but it only is applied when one of the two configurable binary inputs is set to be a motion sensor (see [Configurable Binary Inputs](#) for information on configuring the binary inputs). To disable motion sensing capabilities, set the Motion Sensor Timeout to 0 minutes. See Table 6 to view the available setpoints. See Table 10 for the setpoint values. To adjust the motion sensor timeout:

1. Press the **Menu** icon.
2. Press **Schedule**.
3. Press **Schedule Options**.
4. Press **Motion Sensor Timeout** and adjust accordingly.
5. Press  to save and  to return to the previous screen.



PID/PRAC+ Automatic Control Tuning

The TEC3000 features advanced proportional-integral-derivative (PID) control algorithms to maximize control performance while minimizing excessive cycling and wear on the equipment for all occupied and standby control.

Additionally, the PID features Johnson Controls proprietary PRAC+ (Pattern Recognition Adaptive Control) automatic tuning, which continuously tunes the controller parameters to automatically optimize the control performance to match the equipment and zone. By default, PRAC+ is enabled and immediately begins to tune. To reset tuning at any time to the factory defaults:

1. Press the **Menu** icon.
2. Press **Control Setup**.
3. Press **Tuning**.
4. Press **Reset PID Tuning** and select **Yes**.
5. Press  to save and  to return to the previous screen.

PRAC+ automatic tuning can also be disabled. When disabled, the controller parameters remain at their last values until automatic tuning is re-enabled. To disable automatic tuning:

1. Press the **Menu** icon.
2. Press **Control Setup**.
3. Press **Tuning**.
4. Press **Temp Control Setup**.
5. Select **Manual PID Tuning**.
6. Press  to save and  to return to the previous screen.

As a result of disabling PRAC+ Auto Tuning, you have access to different types of manual tuning that allows modifications of tuning parameters listed under **Control Setup > General** in Table 10.

Table 8: TEC3000 Tuning Types

Tuning Type	Description
Automatic PID Tuning	Automatic tuning in an existing TEC3000

Table 8: TEC3000 Tuning Types

Tuning Type	Description
Deadband Override	There is no deadband in use with proportional devices. This operates in the same way as Automatic PID tuning.
Manual PID Tuning	Manual tuning of Heating and Cooling PIDs. The manual tuning parameters are listed under Control Setup > Tuning in Table 10.

Note: For more details on PID/PRAC+ Automatic Control Tuning, refer to the *Controller Tool Help (LIT-12011147)*.

Configurable Binary Inputs

The thermostat controller supports up to two configurable binary inputs (BIs) that can be used to add additional features to the system. Configurable Binary Inputs are accessed through **Settings > Control Setup > Inputs**. Both BIs can be configured to support the following options:

- **Disabled**—Sets the binary input to an unused state. When disabled, you can use the binary input for monitoring-only without affecting the thermostat functionality.
- **Open Window**—Sensor to shut down control if a window is opened. The controller disables control 60 seconds after detecting an opened window.
- **Open Door**—Works in conjunction with the Motion NO/Motion NC sensor to control occupancy
- **Fan Lock**—Air Proof switch input to shut down control if no airflow is detected within 10 seconds of turning the fan on. Fan Lock must be manually reset from the Faults menu.
- **Service**—Input from the equipment to display a service warning on the thermostat
- **Dirty Filter**—Input from the equipment to display a dirty filter fault on the thermostat
- **Motion NC**—External motion sensor with a closed contact output when no motion is detected
- **Motion NO**—External motion sensor with an open contact output when no motion is detected
- **Temp Occ**—Trigger to place controller into Temporary Occupancy mode
- **Occupancy**—Direct override of Occupied and Unoccupied
- **Supply Fan Status**—Input from the equipment to display a Supply Fan Fault. When Fan Alarm Action is set to Shutdown and the Supply Fan Fault is active, the TEC3000 disables the fan, heating, and cooling. When the Fan Alarm Action is set to Enable and the Supply Fan Fault is active, the TEC3000 allows the fan, heating, and cooling to operate during the Supply Fan Fault.

Setting both BIs to the same function is supported for all except Occupancy, Fan Lock, Open Door, and Open Window. If both BIs are set the same for those four, BI2 is ignored and only BI1 is used.

The Open Door option works in conjunction with a motion sensor, either built into the TEC or connected to another BI configured for Motion NO/NC mode. When the door is open, motion detected by the sensor is ignored. Note that opening the door does not stop an Occupied period started by the motion sensor prior to opening the door.

The polarity of the inputs are provided in Table 9.

Table 9: Input Polarities

BI Configuration	Contact Open	Contact Closed
Occupancy	Unoccupied	Occupied
Temp Occ	No Trigger Active	Temporary Occupancy Trigger ¹
Motion NO	No Motion Detected, Standby	Motion Detected, Occupied ¹
Motion NC	Motion Detected, Occupied ¹	No Motion Detected, Standby
Dirty Filter	Dirty Filter Alarm Inactive	Dirty Filter Alarm ¹
Service	Service Alarm Inactive	Service Alarm ¹

Table 9: Input Polarities

BI Configuration	Contact Open	Contact Closed
Fan Lock	No Airflow	Airflow
Open Door	Door Open, Unoccupied	Door Closed, Occupied
Open Window	Window Open, Control Shut Down	Window Closed, Control Running
Supply Fan Status	Supply Fan Off	Supply Fan On



1. Configurations that support both BIs configured for the same feature of the action that occurs when either of the BIs enter that state.

Aux Control

The TEC has an auxiliary output that can be configured to operate in a few different ways. The Aux Mode supports seven different options:

- Not Used—Output is always off
- Occupied NO—Output is normally open, but closes when occupied
- Occupied NC—Output is normally closed, but opens when occupied
- Occupied Fan NO—Output is normally open, but is closed when occupied with the fan running
- Occupied Fan NC—Output is normally closed, but is open when occupied with the fan running
- On—Output is turned on (relay closed), used by a BAS to directly control the AUX output
- Off—Output is turned off (relay open), used by a BAS to directly control the AUX output

To set the Aux Mode:

1. Press the **Menu** icon.
2. Press **Control Setup**.
3. Press **General**.
4. Press **Aux Mode** and set accordingly.
5. Press  to save and  to return to the previous screen.

This option is also exposed to the BAS through the point AUX-MODE.

When the Reheat installed parameter is set to True, the Aux output is used for Reheat Output. The setting for the Aux Mode is ignored when reheat is enabled.

Commissioning Mode

The thermostat controller has a built-in commissioning mode, which is designed to allow you to quickly test equipment wiring and functionality. Commissioning mode temporarily disables the control logic, and allows you to manually command any individual output. Commissioning is designed to be the last step of the installation process after configuring the controller for the equipment being controlled, and the available options in commissioning mode are dependent on the controller configuration. To enter commissioning mode:

1. Press the **Menu** icon.
2. Select **Commissioning**.
3. Confirm that the selection was intentional. (The control is overridden upon selecting **Confirm**).

Individual outputs can be commanded through this interface. For binary outputs, the options are Off or On; for analog outputs, they can be commanded from 0 to 100%. Whenever a control output is turned on, the fan is engaged for safety purposes. To command an output from the Commissioning menu:

1. Select the output to command. Adjust the value to the desired output and press **Save**. The output immediately changes to that value.
2. Restore the value to the original setting and press **Save** once again to complete testing that output.

Pressing the back icon from the main commissioning menu or allowing the menu system to time out and return to the home screen ends commissioning and puts the control logic back in control of the outputs.

Sensor Priority

The TEC3000 supports various sources of sensor data for use in control or display, including internal sensors, remote sensors (connected using an analog input), or network commanded sensors. The TEC uses the highest priority connected input (network commands followed by remote sensors and then internal sensors) for control and display. Not all sources are available for all sensors.

Network commands operate on a timeout basis. When a network point is written to by a supervisor, the point becomes the highest priority for 15 minutes. If a new update is written within 15 minutes, the timer is restarted for another 15 minutes.

Available Fault Diagnostics

- **Supply Fan Faults**—The TEC3000 supports a configurable Supply Fan Status feedback input that turns on when the Supply Fan Status does not match the Supply Fan Command, and can be configured to disable heating, cooling, and fan commands. The alarm delay is adjustable through the Fan Alarm delay setting. If the delay is set to 0 or the binary input is not defined, this feature becomes disabled.
- **Supply Fan Runtime**—The TEC3000 supports setting runtime limits on the supply fan command. When the limit is exceeded, an alarm turns on. This feature is intended to be used as a maintenance reminder. Setting the runtime limit to 0 disables this feature.
- **Supply Air Temperature Diagnostics**—The TEC3000 supports diagnostics when you have a Supply Air Temperature installed. The TEC3000 monitors the supply air. If you call for cooling or heating and the temperature does not fall or rise by at least the supply air temperature alarm offset value within the supply air temperature alarm delay, an alarm is generated. If the monitoring occurs while cooling, a cooling ineffective alarm is generated. If the monitoring occurs while heating, a heating ineffective alarm is generated. If you set the supply air temperature offset value set to 0, this alarm is disabled.
- **Zone Temperature Alarm**—When enabled, the user can set a low and high temperature alarm; and if the zone temperature rises or falls below those limits, an alarm is generated.
- **Trends**—Built-in trends exist for many of the inputs and outputs for the TEC3000. These trends are viewable at the TEC. The analog graph displays data in 15-minute increments over the previous 24 hours or a table with the last 25 data points. Binary trends display 25 samples taken at every change of state.

Menus and Submenus

In the following table, the * indicates that the menus depend on your configuration.

Table 10: Menus and Submenus (Part 1 of 8)

Level 1	Level 2 (LCD Screen Name)	Level 3 (Default Values)	Available Values ¹
Setpoints	Occ Cooling Setpoint	72°F (22°C)	55 to 85°F (13 to 30°C)
	Occ Heating Setpoint	68°F (20°C)	55 to 85°F (13 to 30°C)
	Unocc Cooling Setpoint	80°F (27°C)	55 to 85°F (13 to 30°C)
	Unocc Heating Setpoint	60°F (15°C)	55 to 85°F (13 to 30°C)
	Stby Cooling Setpoint	74°F (23°C)	55 to 85°F (13 to 30°C)
	Stby Heating Setpoint	66°F (19°C)	55 to 85°F (13 to 30°C)
	Dehumidification*	50% RH	0 to 100% RH *Dehumidification Enable = True
	Occ Setpoint Select	Setpoint Offset	Min and Max Setpoint or Setpoint Offset
	Heat Cool Setpoint Mode	Individual Setpoints	Common Setpoint or Individual Setpoint
	Max Heating Setpoint*	68°F (20°C)	The range (in degrees) from the Min Heating Setpoint temperature to the Min Cooling Setpoint temperature minus 1°F (0.55°C). (The cooling temperature always needs to be 1°F [0.55°C] above the heating temperature.) *These values only appear when Heat Cool Setpoint Mode == Individual Setpoints and Occ Setpoint Select == Min and Max Setpoint.
	Min Heating Setpoint*	60°F (15°C)	45°F (7.22°C) to Max Heating Setpoint *These values only appear when Heat Cool Setpoint Mode == Individual Setpoints and Occ Setpoint Select == Min and Max Setpoint.
	Max Cooling Setpoint*	80°F (27°C)	Min Cooling Setpoint to 100°F (37.77°C) *These values only appear when Heat Cool Setpoint Mode == Individual Setpoints and Occ Setpoint Select == Min and Max Setpoint.
	Min Cooling Setpoint*	72°F (22°C)	The range (in degrees) from the Max Heating Setpoint temperature plus 1°F (0.55°C) to the Max Cooling Setpoint temperature. *These values only appear when Heat Cool Setpoint Mode == Individual Setpoints and Occ Setpoint Select == Min and Max Setpoint.
	Max Setpoint*	80°F (27°C)	Min Setpoint to 100°F (37.77°C) *These values only appear when Heat Cool Setpoint Mode == Common Setpoint and Occ Setpoint Select == Min and Max Setpoint.
Min Setpoint*	60°F (15°C)	45°F (7.22°C) to Max Setpoint *These values only appear when Heat Cool Setpoint Mode == Common Setpoint and Occ Setpoint Select == Min and Max Setpoint.	

Table 10: Menus and Submenus (Part 2 of 8)

Level 1	Level 2 (LCD Screen Name)	Level 3 (Default Values)	Available Values ¹
Schedule	<i>Schedule Options</i>		
	Set Schedule	—	See <i>Scheduling</i>
	Optimal Start Enable	No	Yes or No
	Temp Occ Duration	120 minutes	0 to 300 minutes
	Motion Sensor Timeout	15 minutes	15 to 240 minutes
	Manual Occupancy Mode	No Override	No Override, Occupied, Unoccupied
	Schedule Source	Local	Local or BAS
Display Settings	Passcode Enable	No	Yes or No
	Passcode*	NA	0000 to 9999 *Passcode Enable = Yes
	Brightness Setting	8	0 to 10 (most dim to brightest)
	Enable Backlight Timeout	Yes	Yes or No
	Units	IP	IP or SI
	Time	N/A	—
	Time Zone	Central	All World Time Zones
	Set Time Format	24 hour	24 hour or 12 hour
	Date	N/A	—
	Set Date Format	YYYY-MM-DD	YYYY-MM-DD, or Day, Month DD, YYYY, or MM-DD-YYYY
	Language	English	English, French, Spanish
	Show Fan Icon	Yes	Yes or No
	Show Temp	Yes	Yes or No
	Show Humidity	Yes	Yes or No
	Show Off Icon	Yes	Yes or No
	Show Hold Icon	Yes	Yes or No
	Show Setpoint	Yes	Yes or No
	Show Alarms	Yes	Yes or No
Show Occ Status	Yes	Yes or No	
Show Unit Status	Yes	Yes or No	
Show Date/Time	Yes	Yes or No	
Control Setup	<i>General</i>		
	Control Mode	Auto	Auto, Cooling, or Heating
	Unit Enable	Enable	Enable or Shutdown
	Fan Mode*	Smart	On, Auto, and Smart for single- and variable-speed fans. Low, Medium, High, Auto, and Smart for multi-speed units. * Fan Coil units only
	Max Setpoint Offset	3 degrees	0 to 20 degrees (°F or °C based on Units setting under Display Settings menu)
	Fan On Delay*	30 seconds	0 to 120 seconds * Fan coil units only

Table 10: Menus and Submenus (Part 3 of 8)

Level 1	Level 2 (LCD Screen Name)	Level 3 (Default Values)	Available Values ¹
Control Setup (Cont)	Fan Off Delay*	30 seconds	0 to 120 seconds * Fan coil units only
	Frost Protection	Yes	Yes or No
	Dehumidification Enable*	No	Yes or No * Fan coil units with humidity sensor
	Aux Mode	Not Used	Not Used, Occupied NO, Occupied NC, Occupied Fan NO, Occupied Fan NC, On, Off
	Load Shed Rate Limit	0.066°F	0 to 1°F (0 to 0.5°C)
	Load Shed Adjust	4°F	0 to 8°F (0 to 4°C)
	Fan Alarm Delay	0 seconds	0 to 300 seconds
	Fan Alarm Action*	Enable	Enable or Shutdown * Fan Alarm Delay > 0
	Fan Alarm Reset*	No	Yes or No * When Fan Alarm Delay is greater than 0
	Fan Runtime Limit	0 hours	0 to 9,000 hours
	Fan Runtime Reset*	No	Yes or No * When Fan Runtime Limit is greater than 0
	Supply Air Temperature Alarm Offset	0°F	0 to 10°F (0 to 5.5°C)
	Supply Air Temperature Alarm Delay (when Supply Air Temp Alarm Offset is greater than 0)	300 seconds	300 to 3,600 seconds
	Unocc Low Speed Fan	Disable	Enable or Disable *When Fan Type = Multi-Speed Fan (only available in versions 3.0.4 or greater)
	Inputs		
B11 Config	Disabled	Disabled, Open Window, Open Door, Fan Lock, Service, Dirty Filter, Motion NC, Motion NO, Temp Occ, Occupancy	
B12 Config	Disabled	Disabled, Open Window, Open Door, Fan Lock, Service, Dirty Filter, Motion NC, Motion NO, Temp Occ, Occupancy	
Supply Temp Sensor*	Nickel	Nickel, Platinum, A99B, 2.25k ohm negative temperature coefficient (NTC), 10k ohm NTC, 10k ohm NTC Type 3 * Analog and non-four pipe units	
Supply Temp Offset*	0 degrees	-5 to 5 degrees (°F or °C based on Units setting under Display Settings menu) * Analog Sensor	
Zone Temp Sensor*	Nickel	Nickel, Platinum, A99B, 2.25k ohm NTC, 10k ohm NTC, 10k ohm NTC Type 3 * Analog Sensor	
Zone Temp Sensor Offset	0 degrees	-5 to 5 degrees (°F or °C based on Units setting under Display Settings menu)	
Humidity Offset	0% RH	-15% to 15% RH	
Reset Sensors	False	True or False	
Zone Temp Alarm Enabled	No	Yes or No	

Table 10: Menus and Submenus (Part 4 of 8)

Level 1	Level 2 (LCD Screen Name)	Level 3 (Default Values)	Available Values ¹
Control Setup (Cont)	Zone Temp Alarm Enabled	No	Yes or No
	Zone Temp Low Limit	55°F	32 to 150°F (0 to 65.56°C)
	Zone Temp High Limit	90°F	32 to 150°F (0 to 65.56°C)
	Tuning		
	Temp Control Setup	Automatic PID Tuning	Automatic PID Tuning, Manual PID Tuning, Deadband Override
	Reset PID Tuning	No	Yes or No
	Deadband*	0.7 to 1.5°F	1.0°F (-17.22 °C) *Functionally, this is the PID deadband when the Temp Control Setup is equal to the Deadband Override or Manual PID Tuning. When the Temp Control Setup equals the On/Off Control, the Deadband is used for the On/Off range of the stage equipment. This parameter is hidden when Temp Control Setup equals Automatic PID Tuning.
	Heat Prop Band*	160°F	5 to 10°F (-15 to -1.11°C) *Values only appear when the Temp control equals Manual PID Tuning.
	Heat Integral Time*	729 seconds	300 to 1,600 seconds *Values only appear when the Temp control equals Manual PID Tuning.
	Heat Process Range*	40°F	10 to 100°F (-12.22 to 37.77°C) *Values only appear when the Temp control equals Manual PID Tuning.
	Heat Saturation Time*	600 seconds	60 to 900 seconds *Values only appear when the Temp control equals Manual PID Tuning.
	Heat Time Constant*	720 seconds	360 to 1,440 seconds *Values only appear when the Temp control equals Manual PID Tuning.
	Heat Process Dead Time*	72 seconds	20 to 120 seconds *Values only appear when the Temp control equals Manual PID Tuning.
	Heat Period*	60 seconds	30 to 120 seconds *Values only appear when the Temp control equals Manual PID Tuning.
	Cool Prop Band*	160°F	5 to 10°F (-15 to -1.11°C) *Values only appear when the Temp control equals Manual PID Tuning.
	Cool Integral Time*	729 seconds	300 to 1,600 seconds *Values only appear when the Temp control equals Manual PID Tuning.
	Cool Process Range*	40°F	10 to 100°F (-12.22 to 37.77°C) *Values only appear when the Temp control equals Manual PID Tuning.
Cool Saturation Time*	600 seconds	60 to 900 seconds *Values only appear when the Temp control equals Manual PID Tuning.	

Table 10: Menus and Submenus (Part 5 of 8)

Level 1	Level 2 (LCD Screen Name)	Level 3 (Default Values)	Available Values ¹
Control Setup (Cont.)	Cool Time Constant*	720 seconds	360 to 1,440 seconds *Values only appear when the Temp control equals Manual PID Tuning.
	Cool Process Dead Time*	72 seconds	20 to 120 seconds *Values only appear when the Temp control equals Manual PID Tuning.
	Cool Period*	60 seconds	30 to 120 seconds *Values only appear when the Temp control equals Manual PID Tuning.
	Equipment Size	Normal	Normal or Oversized
Network Setup	FC Comm Mode	BACnet/MSTP	BACnet/MSTP, N2
	BACnet Instance ID*	1	0 to 4,914,302 * BACnet/MSTP communication mode
	N2 Device Address*	4	1 to 255 * N2 communication mode
	BACnet Device Address*	4	4 to 127 * BACnet/MSTP communication mode
	MSTP Baud Rate*	Auto	Auto, 1200, 9600, 19200, 38400, 76800 * BACnet/MSTP communication mode
	BACnet Encoding Type BACnet/MSTP Communication Mode	ISO 10646 (UCS-2)	ISO 10646 (UCS-2), ANSI X3.4 (US-ASCII)
Equipment Setup	General		
	Unit Type	4-Pipe	2-Pipe, 4-Pipe, VAV
	Valve Open Voltage	10 VDC	0 to 10 VDC
	Valve Closed Voltage	0 VDC	0 to 10 VDC
	Unoccupied Off Delay	10 minutes	0 to 10 minutes
	Supply Fan		
	Supply Fan Type*	Single-Speed	Single-Speed, Multi-Speed, Variable-Speed *Fan coil units only
	Start Voltage*	2 VDC	0 to 10 VDC *Fan coil units only, variable speed fan
	Full Speed Voltage*	10 VDC	0 to 10 VDC, proportional *Fan coil units only, variable speed fan
	Min Command*	20%	0 to 100% *Fan coil units only, variable speed fan
	Med Fan Speed On Cmd*	33%	0 to 100% *Fan coil units only, multi-speed fan
	High Fan Speed On Cmd*	66%	0 to 100% *Fan coil units only, multi-speed fan
	Reheat		
	Reheat Installed	No	Yes (True) or No (False)
	Reheat Min Damper Position*	20%	0 to 100% *VAV units with reheat installed
	Reheat Fan Required*	No	Yes or No *Fan coil units with reheat installed

Table 10: Menus and Submenus (Part 6 of 8)

Level 1	Level 2 (LCD Screen Name)	Level 3 (Default Values)	Available Values ¹
Equipment Setup (Cont)	Reheat Min On Time*	180 seconds	0 to 360 second * Reheat installed
	Reheat/ Min Off Time*	180 seconds	0 to 360 seconds * Reheat installed
	Changeover		
	Changeover Mode*	Auto	Auto, Cooling, or Heating * Non 4-Pipe units
	Supply Temp Type*	Analog Sensor	Analog Sensor, Heating NC, Cooling NC * Changeover Mode = Auto
	Changeover Setpoint*	55°F	40 to 200°F (4 to 93°C) * Supply temp type = analog sensor
	Supply Temp Sensor*	Nickel	Nickel, Platinum, A99B, 2.25k ohm NTC, 10k ohm NTC, 10k ohm NTC Type 3 * Supply temp type = analog sensor
	Supply Temp Offset*	0°F	-5 to 5°F (-3 to 3°C) * Supply temp type = analog sensor
Trend	EFF-ZNT	—	-50 to 250°F (-45.56 to 121.11°C)
	EFF-SETPOINT	—	45 to 100°F (7.22 to 37.78°C)
	EFF-ZNH	—	0 to 100%RH
	B1 Status	—	On or Off
	B2 Status	—	On or Off
	EFF-OAT	—	-50 to 250°F (-45.56 to 121.11°C)
	EFF-SAT	—	-50 to 250°F (-45.56 to 121.11°C)
	FANSPD-S	—	On or Off
	HTG-O	—	0 to 100%
	CLG-O	—	0 to 100%
System Status	Occupancy Source	Local Schedule	Occupancy BI Temp Occ BI Temp Occ Occ Override Local Schedule BAS Schedule Occupancy Sensor

Table 10: Menus and Submenus (Part 7 of 8)

Level 1	Level 2 (LCD Screen Name)	Level 3 (Default Values)	Available Values ¹
System Status (Cont)	Unit Status	Cooling	System Fault Airflow Fault Open Window Control Off Unreliable Temperature Dehumidification Idle Cooling Heating Cooling Unavailable Heating Unavailable Cooling Unavailable due to Changeover Cooling Unavailable due to OA Temp Cooling Unavailable due to Control Mode Heating Unavailable due to Changeover Heating Unavailable due to OA Temp Heating Unavailable due to Control Mode
	Supply Air Temperature	75°F	-50 to 250°F (-45 to 121°C)
	Changeover State	Supply Temperature Unreliable	Changeover Disabled Cooling Mode Heating Mode Supply Temperature Unreliable
	Zone Temp Source	Internal Sensor	Unreliable Internal Sensor Remote Sensor Network Override Input Not Installed
Control Status	Cooling % Command	0%	0 to 100%
	Heating % Command	0%	0 to 100%
	Reheat % Command	0%	0 to 100%
	Cool Stage 1	Off	On or Off
	Heat Stage 1	Off	On or Off
	Reheat Stage 1	Off	On or Off
	Fan % Command	0%	0 to 100%
	Fan	On	On or Off when Supply Fan Type = Single-speed or Variable-speed Off, Low, Medium, or High when Supply Fan Type = Multi-speed
Controller Info	Model Name	TEC3x2x-xx	—
	Software Version	x.x.x.xxxx	—
	Unit Name	TECxxxxx	—
	Device Name	—	User-Supplied
	Device Description	TEC3000	—

Table 10: Menus and Submenus (Part 8 of 8)

Level 1	Level 2 (LCD Screen Name)	Level 3 (Default Values)	Available Values ¹
Commissioning	Supply Air Temperature	Display Current Temperature	—
	Heat Command	0%	0 to 100%
	Cool Command	0%	0 to 100%
	Supply Fan	No	Yes or No
	Aux	No	Yes or No
Update	View Version	x.x.x.xxxx	Current Release of Software
	Load Firmware	—	File list from USB drive
	Restore*	—	File list from USB drive or local storage *Configuration can be backed up to the USB drive and restored to similar models to expedite the commissioning process.
	Backup*	—	File list from USB drive or local storage *Configuration can be backed up to the USB drive and restored to similar models to expedite the commissioning process.

1. If the value is outside min/max limits, it is reassigned to the midpoint between min and max.

Troubleshooting

Table 11: Fault List (Part 1 of 3)

Faults	Probable Causes	Solutions
Remote Zone Temp Fail	The External Zone Temperature sensor has been disconnected or has failed.	<ol style="list-style-type: none"> 1. Check the wiring of the sensor. 2. If intentionally disconnected, reset sensors through the menu. 3. If the problem persists, order replacement units and return the affected devices to Johnson Controls under the RMA program.
Supply Temp Fail	The External Supply Temperature sensor has been disconnected or has failed.	<ol style="list-style-type: none"> 1. Check the wiring of the sensor. 2. If intentionally disconnected, result fault by entering the menu, enter Control Setup, and select Inputs reset the sensors. 3. If the problem persists, order replacement units and return the affected devices to Johnson Controls under the RMA program.
Internal Sensor Fail	An internal sensor has failed on the TEC.	Order replacement units and return the affected devices to Johnson Controls under the RMA program.
Dehum Unavailable	Dehumidification is unavailable because the zone humidity sensor has failed or the humidity reading is not reliable.	<ol style="list-style-type: none"> 1. If the source of zone humidity was a BAS, check the BAS to ensure that it is still online and is providing the TEC with the humidity reading. If removal of the BAS mapping was intentional, reset the sensors through the menu. 2. If the problem persists, order replacement units and return the affected devices to Johnson Controls under the RMA program.
Service	Equipment connected to the BI configured for a Service alarm is triggering the alarm.	Service the equipment by way of the manufacturer's recommendation.

Table 11: Fault List (Part 2 of 3)

Faults	Probable Causes	Solutions
Dirty Filter	Equipment connected to the BI configured for a Dirty Filter alarm is triggering the alarm.	Replace the filter in the equipment as explained in the manufacturer's instructions.
Calibration Corrupt	Factory calibration data is lost or is not installed.	Order replacement units and return the affected devices to Johnson Controls under the RMA program.
Changeover Fail	The Supply Temperature Sensor is not installed, has failed, or has been disconnected and the TEC can no longer detect changeover mode to cool or heat.	Follow the same steps as Supply Temp Fail alarm.
Zone Temp Unreliable	All sources of zone temperature are unreliable, including the onboard sensor.	Order replacement units and return the affected devices to Johnson Controls under the RMA program.
Open Window	The switch connected to the BI configured for Open Window is sensing that the window is opened, and control has shut down.	<ol style="list-style-type: none"> 1. Close the window to resume control. 2. Check sensor functionality with an ohmmeter, and verify the wiring to the TEC. 3. Order replacement units and return the affected devices to Johnson Controls under the RMA program.
Fan Lock	The switch connected to the BI configured for Fan Lock did not sense airflow within 10 seconds of starting the fan, and control has been shut down.	<ol style="list-style-type: none"> 1. Inspect equipment to ensure fan functions. 2. Check sensor functionality with an ohmmeter, and verify wiring to the TEC. 3. Reset fault by entering the menu, selecting Fault Status, and selecting the Fan Lock. 4. If problems persist, order replacement units and return the affected devices to Johnson Controls under the RMA program.
Humidity Unreliable	The zone humidity reading was reliable and has now failed.	<ol style="list-style-type: none"> 1. If the source of zone humidity was the onboard sensor, contact Johnson Controls product sales and support. 2. If the source of zone humidity was a BAS, check the BAS to ensure that it is still online and providing the TEC with the humidity reading. If removal of the BAS mapping was intentional, reset sensors through the menu.
Controller Fault	The controller has detected an internal fault that it cannot recover.	Order replacement units and return the affected devices to Johnson Controls under the RMA program.
	An unknown error has prevented the controller from turning on.	Order replacement units and return the affected devices to Johnson Controls under the RMA program.
Touchscreen Unavailable	The touchscreen components have failed to initialize.	<ol style="list-style-type: none"> 1. Reboot the controller. 2. If problems persist, order replacement units and return the affected devices to Johnson Controls under the RMA program.
Board Mismatch	The baseboard and CPU board are paired incorrectly. An error message appears on the TEC indicating the model number of the baseboard and CPU board.	Match the baseboard to its corresponding CPU board. See Figure 5 for information on ensuring that you have the CPU board and base board paired correctly.

Table 11: Fault List (Part 3 of 3)

Faults	Probable Causes	Solutions
Firmware Mismatch	The previous upgrade has not completed.	<ol style="list-style-type: none"> 1. Upgrade the TEC3000 to the latest released version. 2. Upgrade the TEC3000 to the current version again.
	The previous downgrade has not completed because the previous version is no longer supported.	Reboot the TEC3000 to clear the fault.
USB Malfunction	A USB drive has malfunctioned and drawn more than the maximum allowed current.	<ol style="list-style-type: none"> 1. Attempt to insert and use the USB drive again. 2. Try a new USB drive. 3. If problems persist, order replacement units and return the affected devices to Johnson Controls under the RMA program.
Supply Fan Runtime Limit Extended	The Supply Fan Runtime has exceeded the configured Supply Fan Runtime Limit.	<ol style="list-style-type: none"> 1. Service the Supply Fan. 2. Reset the Supply Fan runtime.
Heating Ineffective	The Supply Air Temperature has not increased above the configured Supply Air Temperature Alarm Offset while heating has been active for at least the Supply Air Temperature Alarm Delay.	Verify that the heating elements on the rooftop are functioning properly.
Cooling Ineffective	The Supply Air Temperature has not decreased below the configured Supply Air Temperature Alarm Offset while cooling has been active for at least the Supply Air Temperature Alarm Delay.	Verify that the cooling elements on the rooftop are functioning properly.
Supply Fan Fault	The Supply Fan Status configured for either BI1 or BI2 has not proved within the configured Fan Alarm Delay.	<ol style="list-style-type: none"> 1. Verify that the Supply Fan is operating when turned on. 2. Verify that the Supply Fan Status wiring is connected correctly.
Zone Temperature Too Cold	The Zone Temperature has decreased below the configured Zone Temp Low Limit.	Verify that the TEC and the RTU heating are enabled and functioning.
Zone Temperature Too Hot	The Zone Temperature has increased above the configured Zone Temp High Limit.	Verify that the TEC and the RTU cooling are enabled and functioning.

Table 12: Troubleshooting Details¹ (Part 1 of 2)

Symptom	Probable Causes	Solutions
The controller displays Idle with a Unit Status of Cooling Unavailable due to Changeover despite being above cooling setpoint, or with a status of Heating Unavailable due to Changeover despite being below the setpoint.	The 2-pipe fan coil/VAV system does not have a changeover sensor and switch connected, or the sensor/switch has failed.	<ol style="list-style-type: none"> 1. Check the wiring of the supply temperature sensor or switch. 2. Verify that the changeover is set up correctly for the type of sensor attached (sensor or switch).
	The changeover temperature is sensing a hot supply, but the controller is requesting cooling.	<ol style="list-style-type: none"> 1. Verify that the supply is not in heating mode. If it is, nothing can be done from the TEC. 2. Check the wiring of the supply temperature sensor or switch. 3. Check the placement of the supply temperature sensor or switch. 4. Verify that the changeover is set up correctly for the type of sensor attached (sensor or switch).
	Changeover temperature is sensing a cold supply, but the controller is requesting heating.	<ol style="list-style-type: none"> 1. Verify that the supply is not in cooling mode. If it is, nothing can be done from the TEC. 2. Check the wiring of the supply temperature sensor or switch. 3. Check the placement of supply temperature sensor or switch. 4. Verify that the changeover is set up correctly for the type of sensor attached (sensor or switch).
The controller displays Idle with a Unit Status of Cooling Unavailable due to Control Mode despite being above cooling setpoint, or with a status of Heating Unavailable due to Control Mode despite being below the setpoint.	The Control Mode is set to Cooling Mode, but the controller is requesting heating.	Change the Control Mode to Auto or Heating.
	The Control Mode is set to Heating Mode, but the controller is requesting cooling.	Change the Control Mode to Auto or Cooling.
The controller provides an error when trying to upgrade firmware.	The firmware on the USB drive is below the minimum required version. Error code 1025.	Please use firmware version 3.0.2.xxxx or higher. A reboot is required to clear the Firmware Mismatch fault that occurs.
The TEC3000 zone temperature does not change fast enough compared to the measured zone temperature from a verification device (a calibrated sensor).	The TEC3000 is configured by default for larger spaces with normal-sized equipment when a proportional device is active.	Select Control Setup > Tuning > Equipment Size > Oversized .
The zone space temperature increases or decreases too much when the unit is active in unoccupied mode.	The heating and cooling equipment are too big for the unoccupied space.	Decrease the Unoccupied Off Delay parameter from 10 minutes to a more appropriate time for the equipment configuration.
The controller provides an error when trying to back up settings.	The USB drive is defective.	Try a different USB drive.
The controller provides an error when trying to restore settings from a backup.	The USB drive is defective.	Try a different USB drive.
	The Restore file is corrupt.	Try restoring a different backup file.
	The Restore file is from an incompatible model TEC.	Ensure that the backup file being restored was from the same model TEC.

Table 12: Troubleshooting Details¹ (Part 2 of 2)

Symptom	Probable Causes	Solutions
The controller is unable to access a USB drive.	The drive is formatted as NTFS or another unsupported format. The TEC supports FAT and FAT32 formats only.	Reformat the USB drive, or try a different USB drive with a supported format.
	The USB drive is defective.	Try a different USB drive.
The controller displays Board Mismatch .	The I/O board that the display board is currently attached to does not match the one that initially shipped with the display board.	Attach the display board to the correct I/O board.
	A hardware failure is causing the two boards to incorrectly identify themselves.	Order replacement units and return the affected devices to Johnson Controls under the RMA program.
The controller displays Controller Fault .	An internal fault was detected and the controller was unable to recover.	Order replacement units and return the affected devices to Johnson Controls under the RMA program.
The Bell icon is displayed on the TEC home page.	The fault has been detected on the TEC.	See Table 11 for TEC fault causes and resolution.
Partial Restore Complete is displayed when trying to restore settings from a backup file.	Not all of the items in the backup file have been restored. This error can be caused by a value being out of the minimum or maximum range in the backup file. It may also occur if there are inconsistencies in the reliability of a setting in the backup file and on the TEC device.	<ol style="list-style-type: none"> 1. Create a Backup file on a USB drive for the TEC that is showing the issue. 2. Edit the backup file created in the previous step on a PC to reflect the desired settings. 3. Verify that the modified values are within minimum and maximum range in the backup file. 4. Restore the settings from the newly edited backup file on the TEC.
The temperature displayed is lower than the actual room temperature.	Cold air drafts are entering the back of the TEC.	Seal any holes behind the TEC to reduce drafts.
	Air is being forced through the TEC from a nearby vent.	Move the location of the TEC or change the venting to prevent air from being forced through the TEC.
The Online icon does not appear for a networked controller.	There is improper field bus wiring.	Refer to the <i>MS/TP Communications Bus Technical Bulletin (LIT-12011034)</i> .
Some icons are hidden.	Lockout levels are used or the icons are hidden due to the display settings.	See Table 4 for lockout levels and access details.

1. For common MS/TP troubleshooting information, refer to the *MS/TP Communications Bus Technical Bulletin (LIT-12011034)*.

Repair Information

If the TEC3000 Series Thermostat Controller fails to operate within its specifications, replace the unit. For a replacement thermostat controller, contact the nearest Johnson Controls representative.

Technical Specifications

TEC3000 Series Proportional Fan Coil and Individual Zone Thermostat Controllers with Dehumidification Capability (Part 1 of 2)

Power Requirements	19 to 30 VAC, 50/60 Hz, 4 VA at 24 VAC nominal, Class 2 or safety extra-low voltage (SELV)
USB Port Power Rating	120 to 250 mA current draw supported
Analog Output Rating	0 to 10 VDC into 2k ohm resistance (minimum)
Fan Relay Output Rating	19 to 30 VAC, 1.0 A maximum, 15 mA minimum, 3.0 A in-rush

TEC3000 Series Proportional Fan Coil and Individual Zone Thermostat Controllers with Dehumidification Capability (Part 2 of 2)

Auxiliary Output Rating/Triac Output		19 to 30 VAC, 1.0 A maximum, 15 mA minimum, 3.0 A in-rush
Binary Inputs		Dry contact across terminal COM to terminals BI1, BI2, or COS
Analog Inputs		Nickel, platinum, A99B, 2.25k ohm NTC, 10k ohm NTC, 10k ohm NTC Type 3 across terminal COM to terminals R SEN or COS
Temperature Sensor Type		Local 1k ohm platinum sensor
Wire Size		18 AWG (1.0 mm diameter) maximum, 22 AWG (0.6 mm diameter) recommended
MS/TP Network Guidelines		Up to 100 devices maximum for each Network Automation Engine (NAE); 4,000 ft (1,219 m) maximum cable length. Refer to the MS/TP Technical Bulletin for the Metasys, FX, or Verasys system installed.
Temperature Range	Backlit Display	-40.0°F/-40.0°C to 122.0°F/50.0°C in 0.5° increments
	Heating Control	40.0°F/4.5°C to 90.0°F/32.0°C
	Cooling Control	54.0°F/12.0°C to 100.0°F/38.0°C
Accuracy	Temperature	±0.9F°/±0.5C° at 70.0°F/21.0°C typical calibrated
	Humidity	±5% RH from 20 to 80% RH at 50 to 90°F (10 to 32°C)
Minimum Deadband		2F°/1C° between heating and cooling
Occupancy Sensor Motion Detection (Occupancy Sensing Models)		Minimum of 94 angular degrees up to a distance of 15 ft (4.6 m); based on a clear line of sight
Ambient Conditions	Operating	32 to 122°F (0 to 50°C); 95% RH maximum, noncondensing
	Storage	-22 to 122°F (-30 to 50°C); 95% RH maximum, noncondensing
Compliance 	BACnet International	BACnet Testing Laboratories™ (BTL) 135-2001 Listed BACnet Application Specific Controller (B-ASC)
	United States	UL Listed, File E27734, CCN XAPX, Under UL60730
		FCC Compliant to CFR 47, Part 15, Subpart B, Class B
	Canada	UL Listed, File E27734, CCN XAPX7, Under E60730
		Industry Canada, ICES-003
	Europe	CE Mark – Johnson Controls declares that this product is in compliance with the essential requirements and other relevant provisions of the EMC Directive and the RoHS Directive.
Australia and New Zealand	RCM Mark, Australia/NZ Emissions Compliant	
Shipping Weight	Models without Occupancy Sensor	0.75 lb (0.34 kg)
	Models with Occupancy Sensor	0.77 lb (0.35 kg)

The performance specifications are nominal and conform to acceptable industry standards. For application at conditions beyond these specifications, consult the local Johnson Controls office. Johnson Controls shall not be liable for damages resulting from misapplication or misuse of its products.

European Single Point of Contact:

JOHNSON CONTROLS
WESTENDHOF 3
45143 ESSEN
GERMANY

NA/SA Single Point of Contact:

JOHNSON CONTROLS
507 E MICHIGAN ST
MILWAUKEE WI 53202
USA

APAC Single Point of Contact:

JOHNSON CONTROLS
C/O CONTROLS PRODUCT MANAGEMENT
NO. 22 BLOCK D NEW DISTRICT
WUXI JIANGSU PROVINCE 214142
CHINA



Building Technologies & Solutions
507 E. Michigan Street, Milwaukee, WI 53202

*Metasys® and Johnson Controls® are registered trademarks of Johnson Controls.
All other marks herein are the marks of their respective owners. © 2018 Johnson Controls.*

TEC3000 Series Proportional Fan Coil and Individual Zone Thermostat Controllers with Dehumidification
Capability Installation Instructions